

EXTENSION SPRINGS

Stock sizes in music wire and stainless steel

Henry extension springs have a wide application for experimental, development, prototype and maintenance work, and have been specified, designed and manufactured to high precision standards.

All Henry extension springs have uniform body diameter and are produced with full twist loops.

They are wound with initial tension, therefore some force is required before the coils are initially separated.

Materials

Part numbers starting with E in the following pages:

Music Wire: ASTM A228 or AMS 5112

Stainless Steel: Type 302 per ASTM A313 or AMS 5688 spring temper (Chemical and Physical only)

Part numbers starting with T in the following pages:

Music Wire: DIN 17223 or JIS G4314 SWP-A/B or AMS 5112

Stainless Steel: Type 301, 302 or 304 per DIN 17224 or JIS G4314 SUS 302/304 or AMS 5688 spring temper (chemical and physical only)

Music wire will be furnished unless stainless steel is specified. When inquiring or ordering, please use letter "M" or Letter "S" as suffix to designate music wire or stainless steel, respectively.

Music wire springs are not recommended for applications where the temperature exceeds 121 degrees C. (250 degrees F.). Stainless steel is not recommended above 260 degrees C. (500 degrees F.).

Stainless steel is slightly magnetic due to cold working during manufacturing. Stainless steel springs may have a slight residue of nickel on the surface of the wire. This is normal and will not effect the function of the part.

Wire diameter is prior to forming.

No charge for certificate of compliance when requested; certificate of chemical analysis available only for part numbers starting with E in the following pages (an additional charge applies).

Coil Direction (helix)

Right or left according to machine set-up at time of run.

Free Length

Free length is reference or approximate only.

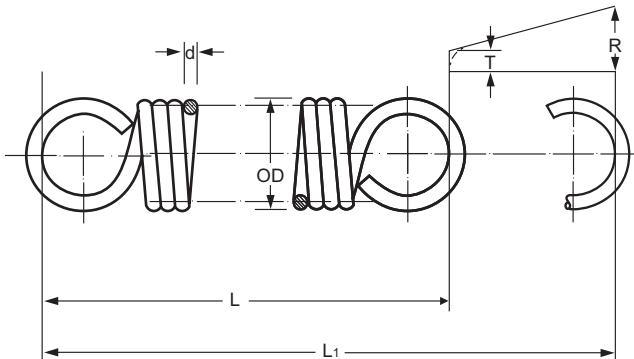

Ends

Full twist loop. Special ends on request.

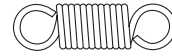

End Position

Part numbers starting with E in the following pages:

The majority of the parts are in-line within +/- 22 degrees. All springs have full twist loops, but physical shape may appear different. If ends are critical to your application, please contact our Engineering Department.

Part numbers starting with T in the following pages:

End position is in line per DIN 2097.

Tolerances

Part numbers starting with E in the following pages:

O.D. (English)	O.D. (Metric)
0.063 to 0.119" +/- 0.003"	1.60 to 3.02 mm +/- 0.08 mm
0.120 to 0.240" +/- 0.005"	3.05 to 6.10 mm +/- 0.13 mm
0.241 to 0.500" +/- 0.008"	6.12 to 12.70 mm +/- 0.20 mm
0.501 to 1.000" +/- 0.015"	12.73 to 25.40 mm +/- 0.38 mm
1.001 to 1.225" +/- 0.020"	25.43 to 31.12 mm +/- 0.51 mm
1.226 to 1.460" +/- 0.030"	31.14 to 37.08 mm +/- 0.76 mm
1.461 to 2.000" +/- 0.040"	37.11 to 50.80 mm +/- 1.02 mm

Part numbers starting with T in the following pages:

All dimensions, loads and rates listed are to DIN 2095 (Grade 2).

Loads & Spring Rate

Initial tension T is for reference only and will vary.

Load and rate values are shown for both music wire and stainless steel in their respective columns.

Load P at L₁ and spring rate R are +/- 10.0% - load at any other point is for reference only. Maximum load P is attained at extended length L₁.

Load values at lengths other than L₁, can be approximated by multiplying the proposed deflection by the rate R and adding the initial tension T. $P = (L - L_x) \times R + T$ where L_x is the new extended length. Load at L_x should be reference only. Contact our Engineering Department if more stringent requirements are needed.

Surface Finish

Music wire: Oil.

Stainless steel: Only part numbers starting with E in the following pages are passivated. All others are plain wire.

Special finishes available upon request.

Packaging

Parts are bulk-packed. Due to physical characteristics, tangling can occur during transit on wire sizes under .035" (.89mm). Please inquire about special packaging when ordering.

OD = Outside diameter

d = Wire diameter

L = Free length (reference use only inside hooks)

L₁ = Maximum extended length

P = Load at L₁

R = Rate

T = Initial Tension

HENRY® www.hlspring.com

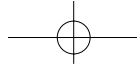

拉伸弹簧

乐器金属弦线和不锈钢常备元件

Henry 拉伸弹簧按照高精度标准设计和制造，可广泛应用于试验、研发、试生产和维护工作。

Henry 拉伸弹簧有相同的簧体直径，是用与簧体直径相同的弯曲环制成的。

开始绕制时有张力，在开始分离线圈时也需要用一些力。

材质

以下页面中编号以E开头的部件：

乐器金属弦线：ASTMA228 或 AMS 5112
不锈钢金属线：302 不锈钢，符合ASTMA313 或 AMS 5688，
弹簧经过回火处理（仅理化处理）

以下页面中编号以T开头的部件：

乐器金属弦线：符合DIN 17223 或 JIS G4314 SWP-A/B
或 AMS 5112
不锈钢金属线：301、302 或 304 不锈钢，符合 DIN 17224
或 JIS G4314 SUS 302/304 或 AMS 5688，弹簧经过回火
处理（仅理化处理）

除非指定使用不锈钢，一般情况下应当使用制造乐器弦线所用的金属线。在询价和定货时，使用字母“M”或者字母“S”，分别表示不锈钢和制造乐器弦线所用的金属线。

当温度超过121摄氏度（250华氏度）时，不建议使用以制造乐器的金属弦线为材质的弹簧。当温度超过260摄氏度（500华氏度）时，不建议使用不锈钢制成的弹簧。

生产过程中进行冷加工时，不锈钢金属线会带有轻微的磁性。不锈钢金属线弹簧的钢丝表面上可能会残留少量的镍。这种情况是正常的，不会影响零部件的功能。

金属线的直径是指成型前的直径。

您可以免费索取产品的合格证书；以下页面中，仅编号以E开头的零部件附有化学分析证书（需要支付额外的费用）。

螺旋方向

右手或左手螺旋方向，根据机器运转时的布局方向而定。

自由长度

自由长度是估计值，仅供参考。

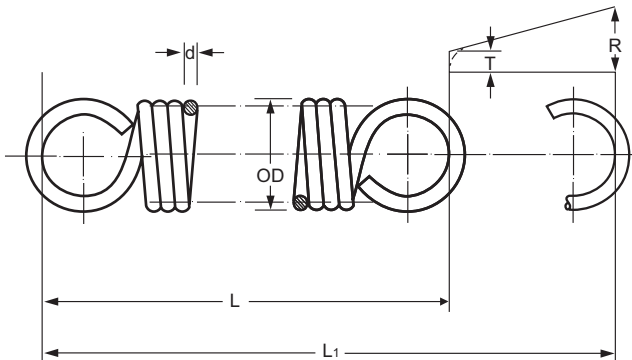

末端

全弯环。根据要求，还可提供特殊的末端。

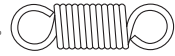

末端位置

以下页面中编号以E开头的部件：

T大多数零件加工成±22度。所有的弹簧都有弯曲环，但是物理形状可能看上去略有不同。如果末端位置是非常重要的，请联系我公司的工程部。

以下页面中编号以T开头的部件：

末端位置的加工符合DIN 2097。

公差

以下页面中编号以E开头的部件：

外径（英制）	外径（公制）
0.063 至 0.119" +/- 0.003"	1.60 至 3.02 mm +/- 0.08 mm
0.120 至 0.240" +/- 0.005"	3.05 至 6.10 mm +/- 0.13 mm
0.241 至 0.500" +/- 0.008"	6.12 至 12.70 mm +/- 0.20 mm
0.501 至 1.000" +/- 0.015"	12.73 至 25.40 mm +/- 0.38 mm
1.001 至 1.225" +/- 0.020"	25.43 至 31.12 mm +/- 0.51 mm
1.226 至 1.460" +/- 0.030"	31.14 至 37.08 mm +/- 0.76 mm
1.461 至 2.000" +/- 0.040"	37.11 至 50.80 mm +/- 1.02 mm

以下页面中编号以T开头的部件：

所有列出的尺寸、承载载荷和弹性系数符合DIN 2095（2级）。

承载载荷与弹性系数

初始张力T仅供参考，因具体情况而不同。

承载载荷与弹性系数值分别在乐器金属弦线和不锈钢金属线表格中给列出。

L₁下的承载载荷P和弹性系数R为±10.0%——任何其它点的承载载荷仅供参考。在拉伸长度L₁时达到最大载荷P。

L₁以外的其它长度下的承载载荷估算值可通过预定变形量乘以弹性系数R再加上初始张力T算出。P = (L - L_x) x R + T，L_x为新的工作高度。L_x的承载载荷仅供参考。如果您需要更高标准，请联系我们的工程部门。

末道漆层

乐器金属弦线：油。

不锈钢：以下页面中仅以E字开头的部件是钝化的，其他所有的是光面钢丝。

根据要求，还可提供特殊的末道漆层。

包装

我们的产品均为批量包装形式。由于材质的物理特性，在运输过程中，直径小于0.035" (0.89mm)的钢丝会发生缠绕。因此，订购时请要求特殊包装。

OD = 外径

d = 线径

L = 自由高度（仅供参考，钩环内部）

L₁ = 最大拉伸长度

P = L₁下的承载载荷

R = 弹性系数

T = 初始张力

HENRY® www.hlspring.com
Tel +86-0511-8803-6999 101

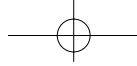

MUSIC WIRE 乐器金属弦线												STAINLESS STEEL 不锈钢金属线											
Catalog Number 编号	Outside Diameter (OD) 外径 (OD)		Wire Diameter (d) 线径 (d)		Free Length L, Approx 自由长度L (估算值)		Ext. L ₁ 拉伸长度L ₁		Load P at L ₁ L ₁ 下的承载 载荷P		Initial Tension, T (Ref. only) 初始张力T (仅供参考)		Spring Rate R 弹性系数R		Catalog Number 编号	Load P at L ₁ L ₁ 下的承载 载荷P		Initial Tension T (Ref. only) 初始张力T (仅供参考)		Spring Rate R 弹性系数R			
	in	mm	in	mm	in	mm	in	mm	lb	N	lb	N	lb/in	N/mm		lb	N	lb	N	lb/in	N/mm		
E0063-007-0250-M					0.250	6.35	0.54	13.72					1.0	0.175	E0063-007-0250-S							0.83	0.15
E0063-007-0310-M					0.310	7.87	0.73	18.54					0.7	0.123	E0063-007-0310-S							0.58	0.10
E0063-007-0380-M			0.007	0.18	0.380	9.65	0.93	23.62	0.32	1.423	0.03	0.13	0.5	0.088	E0063-007-0380-S	0.27	1.18	0.02	0.11			0.42	0.07
E0063-007-0440-M					0.440	11.18	1.12	28.45					0.4	0.070	E0063-007-0440-S							0.33	0.06
E0063-007-0500-M					0.500	12.70	1.31	33.27					0.4	0.070	E0063-007-0500-S							0.33	0.06
E0063-008-0250-M					0.250	6.35	0.46	11.68					2.0	0.350	E0063-008-0250-S							1.67	0.29
E0063-008-0310-M					0.310	7.87	0.60	15.24					1.4	0.245	E0063-008-0310-S							1.17	0.20
E0063-008-0380-M					0.380	9.65	0.75	19.05					1.1	0.193	E0063-008-0380-S							0.92	0.16
E0063-008-0440-M			0.008	0.20	0.440	11.18	0.91	23.11	0.45	2.00	0.04	0.18	0.9	0.158	E0063-008-0440-S	0.38	1.67	0.03	0.15			0.75	0.13
E0063-008-0500-M					0.500	12.70	1.05	26.67					0.7	0.123	E0063-008-0500-S							0.58	0.10
E0063-008-0620-M					0.620	15.75	1.34	34.04					0.6	0.105	E0063-008-0620-S							0.50	0.09
E0063-008-0750-M					0.750	19.05	1.64	41.66					0.5	0.088	E0063-008-0750-S							0.42	0.07
E0063-009-0250-M					0.250	6.35	0.40	10.16					3.7	0.648	E0063-009-0250-S							3.08	0.54
E0063-009-0310-M	0.063	1.60			0.310	7.87	0.52	13.21					2.7	0.473	E0063-009-0310-S							2.25	0.39
E0063-009-0380-M					0.380	9.65	0.65	16.51					2.1	0.368	E0063-009-0380-S							1.75	0.31
E0063-009-0440-M			0.009	0.23	0.440	11.18	0.77	19.56	0.62	2.76	0.06	0.27	1.7	0.298	E0063-009-0440-S	0.52	2.30	0.05	0.22			1.42	0.25
E0063-009-0500-M					0.500	12.70	0.90	22.86					1.4	0.245	E0063-009-0500-S							1.17	0.20
E0063-009-0620-M					0.620	15.75	1.13	28.70					1.1	0.193	E0063-009-0620-S							0.92	0.16
E0063-009-0750-M					0.750	19.05	1.40	35.56					0.9	0.158	E0063-009-0750-S							0.75	0.13
E0063-011-0250-M					0.250	6.35	0.34	8.64					11.1	1.944	E0063-011-0250-S							9.25	1.62
E0063-011-0310-M					0.310	7.87	0.44	11.18					7.9	1.384	E0063-011-0310-S							6.58	1.15
E0063-011-0380-M					0.380	9.65	0.55	13.97					5.9	1.033	E0063-011-0380-S							4.91	0.86
E0063-011-0440-M			0.011	0.28	0.440	11.18	0.65	16.51	1.09	4.85	0.10	0.44	4.8	0.841	E0063-011-0440-S	0.91	4.04	0.08	0.37			4.00	0.70
E0063-011-0500-M					0.500	12.70	0.74	18.80					4.1	0.718	E0063-011-0500-S							3.42	0.60
E0063-011-0620-M					0.620	15.75	0.93	23.62					3.2	0.560	E0063-011-0620-S							2.67	0.47
E0063-011-0750-M					0.750	19.05	1.14	28.96					2.5	0.438	E0063-011-0750-S							2.08	0.37
E0094-010-0380-M					0.380	9.65	0.84	21.34					1.2	0.210	E0094-010-0380-S							1.00	0.18
E0094-010-0440-M					0.440	11.18	1.03	26.16					0.9	0.158	E0094-010-0440-S							0.75	0.13
E0094-010-0500-M					0.500	12.70	1.23	31.24					0.8	0.140	E0094-010-0500-S							0.67	0.12
E0094-010-0620-M			0.010	0.25	0.620	15.75	1.60	40.64	0.60	2.67	0.05	0.22	0.6	0.105	E0094-010-0620-S	0.50	2.22	0.04	0.18			0.50	0.09
E0094-010-0750-M					0.750	19.05	2.00	50.80					0.4	0.070	E0094-010-0750-S							0.33	0.06
E0094-010-0880-M					0.880	22.35	2.33	59.18					0.3	0.053	E0094-010-0880-S							0.25	0.04
E0094-010-1000-M					1.000	25.40	2.69	68.33					0.3	0.053	E0094-010-1000-S							0.25	0.04
E0094-011-0380-M					0.380	9.65	0.72	18.29					1.9	0.333	E0094-011-0380-S							1.58	0.28
E0094-011-0440-M					0.440	11.18	0.87	22.10					1.5	0.263	E0094-011-0440-S							1.25	0.22
E0094-011-0500-M					0.500	12.70	1.03	26.16					1.2	0.210	E0094-011-0500-S							1.00	0.18
E0094-011-0620-M			0.011	0.28	0.620	15.75	1.34	34.04	0.70	3.11	0.06	0.27	0.9	0.158	E0094-011-0620-S	0.58	2.59	0.05	0.22			0.75	0.13
E0094-011-0750-M					0.750	19.05	1.68	42.67					0.7	0.123	E0094-011-0750-S							0.58	0.10
E0094-011-0880-M					0.880	22.35	2.02	51.31					0.6	0.105	E0094-011-0880-S							0.50	0.09
E0094-011-1000-M					1.000	25.40	2.33	59.18					0.5	0.088	E0094-011-1000-S							0.42	0.07
E0094-012-0380-M	0.094	2.39			0.380	9.65	0.66	16.76					3.2	0.560	E0094-012-0380-S							2.67	0.47
E0094-012-0440-M					0.440	11.18	0.82	20.83					2.4	0.420	E0094-012-0440-S							2.00	0.35
E0094-012-0500-M					0.500	12.70	0.95	24.13					2.0	0.350	E0094-012-0500-S							1.67	0.29
E0094-012-0620-M			0.012	0.30	0.620	15.75	1.22	30.99	1.00	4.45	0.10	0.44	1.5	0.263	E0094-012-0620-S	0.83	3.71	0.08	0.37			1.25	0.22
E0094-012-0750-M					0.750	19.05	1.50	38.10					1.2	0.210	E0094-012-0750-S							1.00	0.18
E0094-012-0880-M					0.880	22.35	1.82	46.23					1.0	0.175	E0094-012-0880-S							0.83	0.15
E0094-012-1000-M					1.000	25.40	2.10	53.34					0.8	0.140	E0094-012-1000-S							0.67	0.12
E0094-013-0380-M					0.380	9.65	0.60	15.24					4.6	0.806	E0094-013-0380-S							3.83	0.67
E0094-013-0440-M					0.440	11.18	0.73	18.54					3.6	0.630	E0094-013-0440-S							3.00	0.53
E0094-013-0500-M					0.500	12.70	0.85	21.59					3.0	0.525	E0094-013-0500-S							2.50	0.44
E0094-013-0620-M			0.013	0.33	0.620	15.75	1.09	27.69	1.15	5.12	0.10	0.44	2.2	0.385	E0094-013-0620-S	0.96	4.26	0.08	0.37			1.83	0.32
E0094-013-0750-M					0.750	19.05	1.35	34.29					1.7	0.298	E0094-013-0750-S							1.42	0.25
E0094-013-0880-M					0.880	22.35	1.62	41.15					1.4	0.245	E0094-013-0880-S							1.17	0.20
E0094-013-1000-M					1.000	25.40	1.86	47.24					1.2	0.210	E0094-013-1000-S							1.00	0.18
E0094-014-0380-M					0.380	9.65	0.57	14.48					7.1	1.243	E0094-014-0380-S							5.91	1.04
E0094-014-0440-M					0.440	11.18	0.68	17.27					5.5	0.963	E0094-014-0440-S							4.58	0.80
E0094-014-0500-M					0.500	12.70	0.79	20.07					4.6	0.806	E0094-014-0500-S							3.83	0.67
E0094-014-0620-M			0.014	0.36	0.620	15.75	1.01	25.65	1.50	6.67	0.17	0.76	3.4	0.595	E0094-014-0620-S	1.25	5.56	0.14	0.63			2.83	0.50
E0094-014-0750-M					0.750	19.05	1.23	31.24					2.7	0.473	E0094-014-0750-S							2.25	0.39
E0094-014-0880-M					0.880	22.35	1.49	37.85					2.2	0.385	E0094-014-0880-S							1.83	0.32
E0094-014-1000-M					1.000	25.40	1.70	43.18					1.9	0.333	E0094-014-1000-S							1.58	0.28

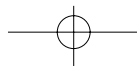

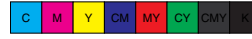
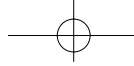

MUSIC WIRE 乐器金属弦线												STAINLESS STEEL 不锈钢金属线											
Catalog Number 编号	Outside Diameter (OD) 外径 (OD)		Wire Diameter (d) 线径 (d)		Free Length L, Approx 自由长度L (估算值)		Ext. L _i 拉伸长度L _i		Load P at L _i L _i 下的承载载荷P		Initial Tension T (Ref. only) 初始张力T (仅供参考)		Spring Rate R 弹性系数R		Catalog Number 编号	Load P at L _i L _i 下的承载载荷P		Initial Tension T (Ref. only) 初始张力T (仅供参考)		Spring Rate R 弹性系数R			
	in	mm	in	mm	in	mm	in	mm	lb	N	lb	N	lb/in	N/mm		lb	N	lb	N	lb/in	N/mm		
E0094-016-0380-M					0.380	9.65	0.52	13.21					14.2	2.490	E0094-016-0380-S					11.83	2.07		
E0094-016-0440-M					0.440	11.18	0.62	15.75					11.0	1.926	E0094-016-0440-S					9.16	1.60		
E0094-016-0500-M					0.500	12.70	0.71	18.03					9.2	1.611	E0094-016-0500-S					7.66	1.34		
E0094-016-0620-M	0.094	2.39	0.016	0.41	0.620	15.75	0.91	23.11	2.15	9.56	0.19	0.85	6.8	1.191	E0094-016-0620-S	1.79	7.96	0.16	0.71	5.66	0.99		
E0094-016-0750-M					0.750	19.05	1.12	28.45					5.3	0.928	E0094-016-0750-S					4.41	0.77		
E0094-016-0880-M					0.880	22.35	1.33	33.78					4.4	0.771	E0094-016-0880-S					3.67	0.64		
E0094-016-1000-M					1.000	25.40	1.52	38.61					3.7	0.648	E0094-016-1000-S					3.08	0.54		
T30800					0.311	7.90	0.378	9.61					45.6	7.980	T40800					37.98	6.65		
T30810	0.098	2.50	0.020	0.50	0.429	10.90	0.537	13.64	3.62	16.10	0.55	2.45	28.4	4.980	T40810	3.02	13.41	0.46	2.04	23.66	4.15		
T30820					0.606	15.40	0.775	19.68					18.2	3.190	T40820					15.16	2.66		
T30930					0.346	8.80	0.424	10.78					46.7	8.180	T40930					38.90	6.81		
T30940	0.110	2.80	0.022	0.55	0.476	12.10	0.601	15.27	4.27	19.00	0.63	2.79	29.2	5.110	T40940	3.56	15.83	0.53	2.33	24.32	4.26		
T30950					0.669	17.00	0.865	21.96					18.7	3.270	T40950					15.58	2.72		
T31050					0.382	9.70	0.455	11.55					69.1	12.100	T41050					57.56	10.08		
T31060	0.118	3.00	0.025	0.63	0.531	13.50	0.648	16.46	5.89	26.20	0.88	3.92	42.9	7.510	T41060	4.91	21.82	0.74	3.27	35.74	6.26		
T31070					0.756	19.20	0.938	23.82					27.5	4.810	T41070					22.91	4.01		
E0120-014-0620-M					0.620	15.75	1.25	31.75					1.6	0.280	E0120-014-0620-S					1.33	0.23		
E0120-014-0750-M					0.750	19.05	1.58	40.13					1.2	0.210	E0120-014-0750-S					1.00	0.18		
E0120-014-0880-M					0.880	22.35	1.92	48.77					1.0	0.175	E0120-014-0880-S					0.83	0.15		
E0120-014-1000-M			0.014	0.36	1.000	25.40	2.23	56.64	1.12	4.98	0.10	0.44	0.8	0.140	E0120-014-1000-S	0.93	4.15	0.08	0.37	0.67	0.12		
E0120-014-1120-M					1.120	28.45	2.53	64.26					0.7	0.123	E0120-014-1120-S					0.58	0.10		
E0120-014-1250-M					1.250	31.75	2.87	72.90					0.6	0.105	E0120-014-1250-S					0.50	0.09		
E0120-014-1370-M					1.370	34.80	3.17	80.52					0.6	0.105	E0120-014-1370-S					0.50	0.09		
E0120-014-1500-M					1.500	38.10	3.51	89.15					0.5	0.088	E0120-014-1500-S					0.42	0.07		
E0120-016-0380-M					0.380	9.65	0.57	14.48					7.9	1.384	E0120-016-0380-S					6.58	1.15		
E0120-016-0500-M					0.500	12.70	0.82	20.83					4.6	0.806	E0120-016-0500-S					3.83	0.67		
E0120-016-0620-M					0.620	15.75	1.07	27.18					3.3	0.578	E0120-016-0620-S					2.75	0.48		
E0120-016-0750-M					0.750	19.05	1.34	34.04					2.5	0.438	E0120-016-0750-S					2.08	0.37		
E0120-016-0880-M					0.880	22.35	1.62	41.15					2.0	0.350	E0120-016-0880-S					1.67	0.29		
E0120-016-1000-M			0.016	0.41	1.000	25.40	1.81	45.97	1.60	7.12	0.20	0.89	1.7	0.298	E0120-016-1000-S	1.33	5.93	0.17	0.74	1.42	0.25		
E0120-016-1120-M					1.120	28.45	2.07	52.58					1.4	0.245	E0120-016-1120-S					1.17	0.20		
E0120-016-1250-M					1.250	31.75	2.31	58.67					1.3	0.228	E0120-016-1250-S					1.08	0.19		
E0120-016-1370-M					1.370	34.80	2.57	65.28					1.1	0.193	E0120-016-1370-S					0.92	0.16		
E0120-016-1500-M					1.500	38.10	2.82	71.63					1.0	0.175	E0120-016-1500-S					0.83	0.15		
E0120-016-1750-M					1.750	44.45	3.45	87.63					0.9	0.158	E0120-016-1750-S					0.75	0.13		
E0120-016-2000-M	0.120	3.05			2.000	50.80	3.97	100.84					0.7	0.123	E0120-016-2000-S					0.58	0.10		
E0120-018-0380-M					0.380	9.65	0.52	13.21					14.4	2.520	E0120-018-0380-S					12.00	2.10		
E0120-018-0500-M					0.500	12.70	0.74	18.80					8.6	1.506	E0120-018-0500-S					7.16	1.25		
E0120-018-0620-M					0.620	15.75	0.95	24.13					6.1	1.068	E0120-018-0620-S					5.08	0.89		
E0120-018-0750-M					0.750	19.05	1.19	30.23					4.7	0.823	E0120-018-0750-S					3.92	0.69		
E0120-018-0880-M					0.880	22.35	1.42	36.07					3.8	0.665	E0120-018-0880-S					3.17	0.55		
E0120-018-1000-M					1.000	25.40	1.60	40.64					3.3	0.578	E0120-018-1000-S					2.75	0.48		
E0120-018-1120-M			0.018	0.46	1.120	28.45	1.81	45.97	2.20	9.79	0.20	0.89	2.8	0.490	E0120-018-1120-S	1.83	8.16	0.17	0.74	2.33	0.41		
E0120-018-1250-M					1.250	31.75	2.03	51.56					2.5	0.438	E0120-018-1250-S					2.08	0.37		
E0120-018-1370-M					1.370	34.80	2.25	57.15					2.2	0.385	E0120-018-1370-S					1.83	0.32		
E0120-018-1500-M					1.500	38.10	2.47	62.74					2.0	0.350	E0120-018-1500-S					1.67	0.29		
E0120-018-1750-M					1.750	44.45	2.90	73.66					1.7	0.298	E0120-018-1750-S					1.42	0.25		
E0120-018-2000-M					2.000	50.80	3.34	84.84					1.4	0.245	E0120-018-2000-S					1.17	0.20		
E0120-018-2250-M					2.250	57.15	3.89	98.81					1.3	0.228	E0120-018-2250-S					1.08	0.19		
E0120-020-0500-M					0.500	12.70	0.68	17.27					15.1	2.640	E0120-020-0500-S					12.58	2.20		
E0120-020-0620-M					0.620	15.75	0.87	22.10					10.8	1.891	E0120-020-0620-S					9.00	1.58		
E0120-020-0750-M					0.750	19.05	1.08	27.43					8.3	1.454	E0120-020-0750-S					6.91	1.21		
E0120-020-0880-M					0.880	22.35	1.29	32.77					6.7	1.173	E0120-020-0880-S					5.58	0.98		
E0120-020-1000-M					1.000	25.40	1.45	36.83					6.0	1.051	E0120-020-1000-S					5.00	0.88		
E0120-020-1120-M			0.020	0.51	1.120	28.45	1.64	41.66	3.00	13.34	0.30	1.33	5.2	0.911	E0120-020-1120-S	2.50	11.11	0.25	1.11	4.33	0.76		
E0120-020-1250-M					1.250	31.75	1.84	46.74					4.5	0.788	E0120-020-1250-S					3.75	0.66		
E0120-020-1370-M					1.370	34.80	2.04	51.82					4.0	0.701	E0120-020-1370-S					3.33	0.58		
E0120-020-1500-M					1.500	38.10	2.23	56.64					3.7	0.648	E0120-020-1500-S					3.08	0.54		
E0120-020-1750-M					1.750	44.45	2.62	66.55					3.1	0.543	E0120-020-1750-S					2.58	0.45		
E0120-020-2000-M					2.000	50.80	3.01	76.45					2.6	0.455	E0120-020-2000-S					2.17	0.38		
E0120-020-2250-M					2.250	57.15	3.47	88.14					2.2	0.385	E0120-020-2250-S					1.83	0.32		

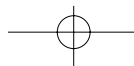

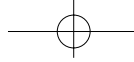

MUSIC WIRE 乐器金属弦线											STAINLESS STEEL 不锈钢金属线										
Catalog Number 编号	Outside Diameter (OD) 外径 (OD)		Wire Diameter (d) 线径 (d)		Free Length L _i , Approx 自由长度L _i (估算值)		Ext. L _i 拉伸长度L _i		Load P at L _i L _i 下的承载载荷P		Initial Tension T (Ref. only) 初始张力T (仅供参考)		Spring Rate R 弹性系数R		Catalog Number 编号	Load P at L _i L _i 下的承载载荷P		Initial Tension T (Ref. only) 初始张力T (仅供参考)		Spring Rate R 弹性系数R	
	in	mm	in	mm	in	mm	in	mm	lb	N	lb	N	lb/in	N/mm		lb	N	lb	N	lb/in	N/mm
E0120-022-0620-M					0.620	15.75	0.81	20.57					18.3	3.200	E0120-022-0620-S					15.24	2.67
E0120-022-0750-M					0.750	19.05	1.00	25.40					14.0	2.450	E0120-022-0750-S					11.66	2.04
E0120-022-0880-M					0.880	22.35	1.19	30.23					11.4	1.996	E0120-022-0880-S					9.50	1.66
E0120-022-1000-M					1.000	25.40	1.36	34.54					9.7	1.699	E0120-022-1000-S					8.08	1.42
E0120-022-1120-M					1.120	28.45	1.54	39.12					8.5	1.489	E0120-022-1120-S					7.08	1.24
E0120-022-1250-M	0.120	3.05	0.022	0.56	1.250	31.75	1.73	43.94	3.89	17.30	0.35	1.56	7.4	1.296	E0120-022-1250-S	3.24	14.41	0.29	1.30	6.16	1.08
E0120-022-1370-M					1.370	34.80	1.90	48.26					6.7	1.173	E0120-022-1370-S					5.58	0.98
E0120-022-1500-M					1.500	38.10	2.09	53.09					6.0	1.051	E0120-022-1500-S					5.00	0.88
E0120-022-1750-M					1.750	44.45	2.45	62.23					5.0	0.876	E0120-022-1750-S					4.17	0.73
E0120-022-2000-M					2.000	50.80	2.82	71.63					4.3	0.753	E0120-022-2000-S					3.58	0.63
E0120-022-2250-M					2.250	57.15	3.18	80.77					3.8	0.665	E0120-022-2250-S					3.17	0.55
E0120-022-2500-M					2.500	63.50	3.54	89.92					3.4	0.595	E0120-022-2500-S					2.83	0.50
T30830					0.374	9.50	0.544	13.82					13.4	2.350	T40830					11.16	1.96
T30840					0.492	12.50	0.764	19.41					8.4	1.470	T40840					7.00	1.23
T30850			0.020	0.50	0.669	17.00	1.094	27.80	2.70	12.00	0.40	1.77	5.4	0.940	T40850	2.25	10.00	0.33	1.47	4.50	0.78
T30860					0.965	24.50	1.646	41.80					3.4	0.590	T40860					2.83	0.49
T30870					1.417	36.00	2.290	58.43					0.3	0.050	T40870					0.25	0.04
T30960					0.390	9.90	0.535	13.58					20.7	3.630	T40960					17.24	3.02
T30970	0.138	3.50	0.022	0.55	0.520	13.20	0.752	19.09	3.53	15.70	0.54	2.38	13.0	2.270	T40970	2.94	13.08	0.45	1.98	10.83	1.89
T30980					0.713	18.10	1.075	27.30					8.3	1.450	T40980					6.91	1.21
T30990					1.039	26.40	1.618	41.10					5.1	0.900	T40990					4.25	0.75
T31170					0.437	11.10	0.530	13.46					63.4	11.100	T41170					52.81	9.25
T31180			0.028	0.70	0.602	15.30	0.751	19.08	6.90	30.70	1.01	4.48	39.7	6.950	T41180	5.75	25.57	0.84	3.73	33.07	5.79
T31190					0.850	21.60	1.083	27.50					25.4	4.440	T41190					21.16	3.70
T31290					0.496	12.60	0.601	15.26					72.5	12.700	T41290					60.39	10.58
T31300	0.157	4.00	0.031	0.80	0.685	17.40	0.853	21.66	8.97	39.90	1.34	5.96	45.7	8.000	T41300	7.47	33.24	1.12	4.96	38.07	6.66
T31310					0.969	24.60	1.231	31.26					29.1	5.100	T41310					24.24	4.25
T31080					0.476	12.10	0.699	17.75					15.8	2.770	T41080					13.16	2.31
T31090			0.025	0.63	0.626	15.90	0.982	24.94	4.11	18.30	0.59	2.61	9.9	1.730	T41090	3.43	15.24	0.49	2.17	8.25	1.44
T31100					0.850	21.60	1.406	35.70					6.3	1.110	T41100					5.25	0.93
T31110	0.177	4.50			1.220	31.00	2.110	53.60					4.0	0.700	T41110					3.33	0.58
T31420					0.559	14.20	0.675	17.15					81.7	14.300	T41420					68.06	11.91
T31430			0.035	0.90	0.772	19.60	0.957	24.32	11.17	49.70	1.67	7.45	51.2	8.960	T41430	9.31	41.40	1.39	6.20	42.65	7.46
T31440					1.091	27.70	1.381	35.08					32.7	5.730	T41440					27.24	4.77
E0180-014-0620-M					0.620	15.75	1.75	44.45					0.6	0.105	E0180-014-0620-S					0.50	0.09
E0180-014-0750-M					0.750	19.05	2.40	60.96					0.4	0.070	E0180-014-0750-S					0.33	0.06
E0180-014-1000-M			0.014	0.36	1.000	25.40	3.69	93.73	0.77	3.42	0.07	0.31	0.3	0.053	E0180-014-1000-S	0.64	2.85	0.06	0.26	0.25	0.04
E0180-014-1250-M					1.250	31.75	4.99	126.75					0.2	0.035	E0180-014-1250-S					0.17	0.03
E0180-014-1500-M					1.500	38.10	6.28	159.51					0.1	0.018	E0180-014-1500-S					0.08	0.02
E0180-018-0620-M					0.620	15.75	1.25	31.75					2.2	0.385	E0180-018-0620-S					1.83	0.32
E0180-018-0750-M					0.750	19.05	1.66	42.16					1.5	0.263	E0180-018-0750-S					1.25	0.22
E0180-018-0880-M					0.880	22.35	2.08	52.83					1.2	0.210	E0180-018-0880-S					1.00	0.18
E0180-018-1000-M					1.000	25.40	2.46	62.48					1.0	0.175	E0180-018-1000-S					0.83	0.15
E0180-018-1120-M					1.120	28.45	2.85	72.39					0.8	0.140	E0180-018-1120-S					0.67	0.12
E0180-018-1250-M			0.018	0.46	1.250	31.75	3.26	82.80	1.55	6.89	0.14	0.62	0.7	0.123	E0180-018-1250-S	1.29	5.74	0.12	0.52	0.58	0.10
E0180-018-1370-M					1.370	34.80	3.65	92.71					0.6	0.105	E0180-018-1370-S					0.50	0.09
E0180-018-1500-M	0.180	4.57			1.500	38.10	4.06	103.12					0.5	0.088	E0180-018-1500-S					0.42	0.07
E0180-018-1750-M					1.750	44.45	4.86	123.44					0.5	0.088	E0180-018-1750-S					0.42	0.07
E0180-018-2000-M					2.000	50.80	5.66	143.76					0.4	0.070	E0180-018-2000-S					0.33	0.06
E0180-018-2250-M					2.250	57.15	6.46	164.08					0.3	0.053	E0180-018-2250-S					0.25	0.04
E0180-018-2500-M					2.500	63.50	7.27	184.66					0.3	0.053	E0180-018-2500-S					0.25	0.04
E0180-020-0620-M					0.620	15.75	1.11	28.19					3.8	0.665	E0180-020-0620-S					3.17	0.55
E0180-020-0750-M					0.750	19.05	1.46	37.08					2.7	0.473	E0180-020-0750-S					2.25	0.39
E0180-020-0880-M					0.880	22.35	1.81	45.97					2.0	0.350	E0180-020-0880-S					1.67	0.29
E0180-020-1000-M					1.000	25.40	2.13	54.10					1.7	0.298	E0180-020-1000-S					1.42	0.25
E0180-020-1120-M			0.020	0.51	1.120	28.45	2.45	62.23	2.08	9.25	0.19	0.85	1.4	0.245	E0180-020-1120-S	1.73	7.71	0.16	0.71	1.17	0.20
E0180-020-1250-M					1.250	31.75	2.80	71.12					1.2	0.210	E0180-020-1250-S					1.00	0.18
E0180-020-1370-M					1.370	34.80	3.12	79.25					1.1	0.193	E0180-020-1370-S					0.92	0.16
E0180-020-1500-M					1.500	38.10	3.47	88.14					1.0	0.175	E0180-020-1500-S					0.83	0.15
E0180-020-1750-M					1.750	44.45	4.14	105.16					0.8	0.140	E0180-020-1750-S					0.67	0.12
E0180-020-2000-M					2.000	50.80	4.81	122.17					0.7	0.123	E0180-020-2000-S					0.58	0.10

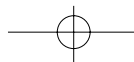

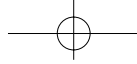

MUSIC WIRE 乐器金属弦线											STAINLESS STEEL 不锈钢金属线										
Catalog Number 编号	Outside Diameter (OD) 外径 (OD)		Wire Diameter (d) 线径 (d)		Free Length L _i , Approx 自由长度L _i (估算值)		Ext. L _i 拉伸长度L _i		Load P at L _i L _i 下的承载 载荷P		Initial Tension, T (Ref. only) 初始张力T (仅供参考)		Spring Rate R 弹性系数 R		Catalog Number 编号	Load P at L _i L _i 下的承载 载荷P		Initial Tension, T (Ref. only) 初始张力T (仅供参考)		Spring Rate R 弹性系数 R	
	in	mm	in	mm	in	mm	in	mm	lb	N	lb	N	lb/in	N/mm		lb	N	lb	N	lb/in	N/mm
E0180-020-2250-M			0.020	0.51	2.250	57.15	5.48	139.19	2.60	11.56	0.20	0.89	0.6	0.105	E0180-020-2250-S	1.73	7.71	0.16	0.71	0.50	0.09
E0180-020-2500-M					2.500	63.50	6.16	156.46					0.5	0.088	E0180-020-2500-S					0.42	0.07
E0180-022-0500-M					0.500	12.70	0.73	18.54					10.5	1.839	E0180-022-0500-S					8.75	1.53
E0180-022-0620-M					0.620	15.75	1.01	25.65					6.3	1.103	E0180-022-0620-S					5.25	0.92
E0180-022-0750-M					0.750	19.05	1.31	33.27					4.4	0.771	E0180-022-0750-S					3.67	0.64
E0180-022-0880-M					0.880	22.35	1.61	40.89					3.4	0.595	E0180-022-0880-S					2.83	0.50
E0180-022-1000-M					1.000	25.40	1.86	47.24					2.8	0.490	E0180-022-1000-S					2.33	0.41
E0180-022-1120-M					1.120	28.45	2.13	54.10					2.4	0.420	E0180-022-1120-S					2.00	0.35
E0180-022-1250-M			0.022	0.56	1.250	31.75	2.43	61.72	3.45	15.35	0.31	1.38	2.0	0.350	E0180-022-1250-S	2.17	9.63	0.17	0.74	1.67	0.29
E0180-022-1370-M					1.370	34.80	2.70	68.58					1.8	0.315	E0180-022-1370-S					1.50	0.26
E0180-022-1500-M					1.500	38.10	2.99	75.95					1.6	0.280	E0180-022-1500-S					1.33	0.23
E0180-022-1750-M					1.750	44.45	3.55	90.17					1.3	0.228	E0180-022-1750-S					1.08	0.19
E0180-022-2000-M					2.000	50.80	4.07	103.38					1.2	0.210	E0180-022-2000-S					1.00	0.18
E0180-022-2250-M					2.250	57.15	4.78	121.41					1.0	0.175	E0180-022-2250-S					0.83	0.15
E0180-022-2500-M					2.500	63.50	5.36	136.14					0.9	0.158	E0180-022-2500-S					0.75	0.13
E0180-024-0620-M					0.620	15.75	0.94	23.88					9.9	1.734	E0180-024-0620-S					8.25	1.44
E0180-024-0750-M					0.750	19.05	1.20	30.48					6.9	1.208	E0180-024-0750-S					5.75	1.01
E0180-024-0880-M					0.880	22.35	1.47	37.34					5.3	0.928	E0180-024-0880-S					4.41	0.77
E0180-024-1000-M					1.000	25.40	1.71	43.43					4.4	0.771	E0180-024-1000-S					3.67	0.64
E0180-024-1120-M					1.120	28.45	1.96	49.78					3.7	0.648	E0180-024-1120-S					3.08	0.54
E0180-024-1250-M			0.024	0.61	1.250	31.75	2.23	56.64	3.45	15.35	0.31	1.38	3.2	0.560	E0180-024-1250-S	2.87	12.79	0.26	1.15	2.67	0.47
E0180-024-1370-M					1.370	34.80	2.47	62.74					2.9	0.508	E0180-024-1370-S					2.42	0.42
E0180-024-1500-M					1.500	38.10	2.74	69.60					2.5	0.438	E0180-024-1500-S					2.08	0.37
E0180-024-1750-M					1.750	44.45	3.25	82.55					2.1	0.368	E0180-024-1750-S					1.75	0.31
E0180-024-2000-M					2.000	50.80	3.76	95.50					1.8	0.315	E0180-024-2000-S					1.50	0.26
E0180-024-2250-M					2.250	57.15	4.27	108.46					1.6	0.280	E0180-024-2250-S					1.33	0.23
E0180-024-2500-M					2.500	63.50	4.78	121.41					1.4	0.245	E0180-024-2500-S					1.17	0.20
E0180-026-0500-M					0.500	12.70	0.66	16.76					24.3	4.260	E0180-026-0500-S					20.24	3.55
E0180-026-0620-M					0.620	15.75	0.88	22.35					15.0	2.630	E0180-026-0620-S					12.50	2.19
E0180-026-0750-M	0.180	4.57			0.750	19.05	1.12	28.45					10.6	1.856	E0180-026-0750-S					8.83	1.55
E0180-026-0880-M					0.880	22.35	1.36	34.54					8.2	1.436	E0180-026-0880-S					6.83	1.20
E0180-026-1000-M					1.000	25.40	1.57	39.88					6.8	1.191	E0180-026-1000-S					5.66	0.99
E0180-026-1120-M					1.120	28.45	1.78	45.21					5.9	1.033	E0180-026-1120-S					4.91	0.86
E0180-026-1250-M			0.026	0.66	1.250	31.75	2.01	51.05	4.20	18.68	0.40	1.78	5.1	0.893	E0180-026-1250-S	3.50	15.56	0.33	1.48	4.25	0.74
E0180-026-1370-M					1.370	34.80	2.24	56.90					4.5	0.788	E0180-026-1370-S					3.75	0.66
E0180-026-1500-M					1.500	38.10	2.47	62.74					4.0	0.701	E0180-026-1500-S					3.33	0.58
E0180-026-1750-M					1.750	44.45	2.91	73.91					3.3	0.578	E0180-026-1750-S					2.75	0.48
E0180-026-2000-M					2.000	50.80	3.36	85.34					2.8	0.490	E0180-026-2000-S					2.33	0.41
E0180-026-2250-M					2.250	57.15	3.88	98.55					2.4	0.420	E0180-026-2250-S					2.00	0.35
E0180-026-2500-M					2.500	63.50	4.34	110.24					2.1	0.368	E0180-026-2500-S					1.75	0.31
E0180-029-0620-M					0.620	15.75	0.82	20.83					26.5	4.640	E0180-029-0620-S					22.07	3.87
E0180-029-0750-M					0.750	19.05	1.03	26.16					18.9	3.310	E0180-029-0750-S					15.74	2.76
E0180-029-0880-M					0.880	22.35	1.24	31.50					14.7	2.570	E0180-029-0880-S					12.25	2.14
E0180-029-1000-M					1.000	25.40	1.43	36.32					12.2	2.140	E0180-029-1000-S					10.16	1.78
E0180-029-1120-M					1.120	28.45	1.63	41.40					10.4	1.821	E0180-029-1120-S					8.66	1.52
E0180-029-1250-M			0.029	0.74	1.250	31.75	1.84	46.74	5.82	25.89	0.52	2.31	9.0	1.576	E0180-029-1250-S	4.85	21.57	0.43	1.92	7.50	1.31
E0180-029-1370-M					1.370	34.80	2.03	51.56					8.0	1.401	E0180-029-1370-S					6.66	1.17
E0180-029-1500-M					1.500	38.10	2.24	56.90					7.1	1.243	E0180-029-1500-S					5.91	1.04
E0180-029-1750-M					1.750	44.45	2.65	67.31					5.9	1.033	E0180-029-1750-S					4.91	0.86
E0180-029-2000-M					2.000	50.80	3.05	77.47					5.0	0.876	E0180-029-2000-S					4.17	0.73
E0180-029-2250-M					2.250	57.15	3.46	87.88					4.4	0.771	E0180-029-2250-S					3.67	0.64
E0180-029-2500-M					2.500	63.50	3.86	98.04					3.9	0.683	E0180-029-2500-S					3.25	0.57
E0180-031-0500-M					0.500	12.70	0.61	15.49					59.4	10.400	E0180-031-0500-S					49.48	8.66
E0180-031-0620-M					0.620	15.75	0.79	20.07					37.8	6.620	E0180-031-0620-S					31.49	5.51
E0180-031-0750-M					0.750	19.05	0.98	24.89					27.1	4.750	E0180-031-0750-S					22.57	3.96
E0180-031-0880-M					0.880	22.35	1.18	29.97					21.1	3.700	E0180-031-0880-S					17.58	3.08
E0180-031-1000-M			0.031	0.79	1.000	25.40	1.35	34.29	6.80	30.25	0.60	2.67	17.8	3.120	E0180-031-1000-S	5.66	25.20	0.50	2.22	14.83	2.60
E0180-031-1120-M					1.120	28.45	1.53	38.86					15.2	2.660	E0180-031-1120-S					12.66	2.22
E0180-031-1250-M					1.250	31.75	1.72	43.69					13.1	2.290	E0180-031-1250-S					10.91	1.91
E0180-031-1370-M					1.370	34.80	1.91	48.51					11.6	2.030	E0180-031-1370-S					9.66	1.69
E0180-031-1500-M					1.500	38.10	2.09	53.09					10.5	1.839	E0180-031-1500-S					8.75	1.53

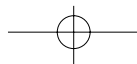

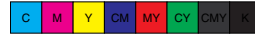
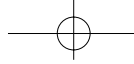

MUSIC WIRE 乐器金属弦线												STAINLESS STEEL 不锈钢金属线											
Catalog Number 编号	Outside Diameter (OD) 外径 (OD)		Wire Diameter (d) 线径 (d)		Free Length L, Approx 自由长度L (估算值)		Ext. L ₁ 拉伸长度L ₁		Load P at L ₁ L ₁ 下的承载载荷P		Initial Tension T (Ref. only) 初始张力T (仅供参考)		Spring Rate R 弹性系数R		Catalog Number 编号	Load P at L ₁ L ₁ 下的承载载荷P		Initial Tension T (Ref. only) 初始张力T (仅供参考)		Spring Rate R 弹性系数R			
	in	mm	in	mm	in	mm	in	mm	lb	N	lb	N	lb/in	N/mm		lb	N	lb	N	lb/in	N/mm		
E0180-031-1750-M					1.750	44.45	2.46	62.48					8.7	1.524	E0180-031-1750-S							7.25	1.27
E0180-031-2000-M					2.000	50.80	2.83	71.88					7.5	1.313	E0180-031-2000-S							6.25	1.09
E0180-031-2250-M			0.031	0.79	2.250	57.15	3.20	81.28	6.80	30.25	0.60	2.67	6.5	1.138	E0180-031-2250-S	5.66	25.20	0.50	2.22			5.41	0.95
E0180-031-2500-M					2.500	63.50	3.63	92.20					5.6	0.981	E0180-031-2500-S							4.66	0.82
E0180-031-2750-M					2.750	69.85	4.01	101.85					5.1	0.893	E0180-031-2750-S							4.25	0.74
E0180-034-0620-M					0.620	15.75	0.75	19.05					61.8	10.820	E0180-034-0620-S							51.48	9.01
E0180-034-0750-M					0.750	19.05	0.93	23.62					44.7	7.830	E0180-034-0750-S							37.24	6.52
E0180-034-0880-M					0.880	22.35	1.11	28.19					35.0	6.130	E0180-034-0880-S							29.16	5.11
E0180-034-1000-M					1.000	25.40	1.28	32.51					29.2	5.110	E0180-034-1000-S							24.32	4.26
E0180-034-1120-M	0.180	4.57			1.120	28.45	1.45	36.83					25.0	4.380	E0180-034-1120-S							20.83	3.65
E0180-034-1250-M					1.250	31.75	1.63	41.40					21.6	3.780	E0180-034-1250-S							17.99	3.15
E0180-034-1370-M			0.034	0.86	1.370	34.80	1.79	45.47	8.97	39.90	0.81	3.60	19.3	3.380	E0180-034-1370-S	7.47	33.24	0.67	3.00			16.08	2.82
E0180-034-1500-M					1.500	38.10	1.97	50.04					17.2	3.010	E0180-034-1500-S							14.33	2.51
E0180-034-1750-M					1.750	44.45	2.32	58.93					14.3	2.500	E0180-034-1750-S							11.91	2.08
E0180-034-2000-M					2.000	50.80	2.67	67.82					12.2	2.140	E0180-034-2000-S							10.16	1.78
E0180-034-2250-M					2.250	57.15	3.02	76.71					10.7	1.874	E0180-034-2250-S							8.91	1.56
E0180-034-2500-M					2.500	63.50	3.36	85.34					9.5	1.664	E0180-034-2500-S							7.91	1.39
E0180-034-2750-M					2.750	69.85	3.71	94.23					8.5	1.489	E0180-034-2750-S							7.08	1.24
T31200					0.531	13.50	0.778	19.75					17.5	3.070	T41200							14.58	2.56
T31210			0.028	0.70	0.697	17.70	1.091	27.70	5.08	22.60	0.76	3.39	11.0	1.920	T41210	4.23	18.83	0.64	2.83			9.16	1.60
T31220					0.945	24.00	1.559	39.60					7.0	1.230	T41220							5.83	1.03
T31230	0.197	5.00			1.358	34.50	2.343	59.50					4.4	0.770	T41230							3.67	0.64
T31540					0.622	15.80	0.750	19.05					90.8	15.900	T41540							75.64	13.25
T31550			0.039	1.00	0.858	21.80	1.063	27.00	13.67	60.80	2.06	9.17	56.5	9.900	T41550	11.39	50.65	1.72	7.64			47.06	8.25
T31560					1.213	30.80	1.532	38.92					36.4	6.370	T41560							30.32	5.31
T30880					0.500	12.70	1.016	25.80					2.9	0.510	T40880							2.42	0.43
T30890					0.618	15.70	1.441	36.60					1.8	0.310	T40890							1.50	0.26
T30900			0.020	0.50	0.795	20.20	2.083	52.90	1.75	7.80	0.23	1.02	1.2	0.210	T40900	1.46	6.50	0.19	0.85			1.00	0.18
T30910					1.091	27.70	3.150	80.00					0.7	0.130	T40910							0.58	0.11
T30920					1.484	37.70	4.571	116.10					0.5	0.090	T40920							0.42	0.08
T31320					0.591	15.00	0.843	21.40					22.8	4.000	T41320							18.99	3.33
T31330	0.217	5.50			0.780	19.80	1.181	30.00					14.3	2.500	T41330							11.91	2.08
T31340			0.031	0.80	1.063	27.00	1.693	43.00	6.79	30.20	1.08	4.79	9.1	1.600	T41340	5.66	25.16	0.90	3.99			7.58	1.33
T31350					1.535	39.00	2.543	64.60					5.7	1.000	T41350							4.75	0.83
T31360					11.417	290.00	20.276	515.00					0.6	0.110	T41360							0.50	0.09
T31670					0.685	17.40	0.824	20.94					99.9	17.500	T41670							83.22	14.58
T31680			0.043	1.10	0.945	24.00	1.168	29.66	16.37	72.80	2.42	10.77	62.8	11.000	T41680	13.63	60.64	2.02	8.97			52.31	9.16
T31690					1.335	33.90	1.683	42.74					40.0	7.000	T41690							33.32	5.83
T31000					0.547	13.90	1.102	28.00					3.3	0.580	T41000							2.75	0.48
T31010					0.677	17.20	1.563	39.70					2.1	0.360	T41010							1.75	0.30
T31020			0.022	0.55	0.870	22.10	2.252	57.20	2.14	9.50	0.25	1.09	1.3	0.230	T41020	1.78	7.91	0.21	0.91			1.08	0.19
T31030					1.197	30.40	3.409	86.60					0.9	0.150	T41030							0.75	0.13
T31040	0.236	6.00			1.630	41.40	4.949	125.70					0.6	0.110	T41040							0.50	0.09
T31790					0.748	19.00	0.898	22.80					109.1	19.100	T41790							90.88	15.91
T31800			0.047	1.20	1.031	26.20	1.271	32.28	19.18	85.30	2.84	12.63	68.5	12.000	T41800	15.97	71.05	2.37	10.52			57.06	10.00
T31810					1.457	37.00	1.831	46.50					43.6	7.630	T41810							36.32	6.36
E0240-018-0620-M					0.620	15.75	1.28	32.51					1.6	0.280	E0240-018-0620-S							1.33	0.23
E0240-018-0750-M					0.750	19.05	1.96	49.78					0.9	0.158	E0240-018-0750-S							0.75	0.13
E0240-018-0880-M					0.880	22.35	2.68	68.07					0.6	0.105	E0240-018-0880-S							0.50	0.09
E0240-018-1000-M					1.000	25.40	3.30	83.82					0.5	0.088	E0240-018-1000-S							0.42	0.07
E0240-018-1250-M			0.018	0.46	1.250	31.75	4.65	118.11	1.18	5.25	0.11	0.49	0.3	0.053	E0240-018-1250-S	0.98	4.37	0.09	0.41			0.25	0.04
E0240-018-1500-M					1.500	38.10	5.99	152.15					0.2	0.035	E0240-018-1500-S							0.17	0.03
E0240-018-2000-M					2.000	50.80	8.64	219.46					0.2	0.035	E0240-018-2000-S							0.17	0.03
E0240-018-2500-M	0.240	6.10			2.500	63.50	11.33	287.78					0.1	0.018	E0240-018-2500-S							0.08	0.02
E0240-018-2750-M					2.750	69.85	12.67	321.82					0.1	0.018	E0240-018-2750-S							0.08	0.02
E0240-022-0620-M					0.620	15.75	1.06	26.92					4.3	0.753	E0240-022-0620-S							3.58	0.63
E0240-022-0750-M					0.750	19.05	1.53	38.86					2.4	0.420	E0240-022-0750-S							2.00	0.35
E0240-022-0880-M			0.022	0.56	0.880	22.35	2.00	50.80	2.07	9.21	0.19	0.85	1.7	0.298	E0240-022-0880-S	1.72	7.67	0.16	0.71			1.42	0.25
E0240-022-1000-M					1.000	25.40	2.44	61.98					1.3	0.228	E0240-022-1000-S							1.08	0.19
E0240-022-1120-M					1.120	28.45	2.88	73.15					1.1	0.193	E0240-022-1120-S							0.92	0.16
E0240-022-1250-M					1.250	31.75	3.35	85.09					0.9	0.158	E0240-022-1250-S							0.75	0.13

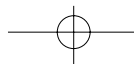

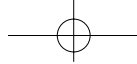

MUSIC WIRE 乐器金属弦线											STAINLESS STEEL 不锈钢金属线											
Catalog Number 编号	Outside Diameter (OD) 外径 (OD)		Wire Diameter (d) 线径 (d)		Free Length L, Approx 自由长度L (估算值)		Ext. L ₁ 拉伸长度 L ₁		Load P at L ₁ L ₁ 下的承载载荷P		Initial Tension T (Ref. only) 初始张力T (仅供参考)		Spring Rate R 弹性系数 R		Catalog Number 编号	Load P at L ₁ L ₁ 下的承载载荷P		Initial Tension T (Ref. only) 初始张力T (仅供参考)		Spring Rate R 弹性系数 R		
	in	mm	in	mm	in	mm	in	mm	lb	N	lb	N	lb/in	N/mm		lb	N	lb	N	lb/in	N/mm	
E0240-022-1370-M					1.370	34.80	3.78	96.01					0.8	0.140	E0240-022-1370-S						0.67	0.12
E0240-022-1500-M					1.500	38.10	4.26	108.20					0.7	0.123	E0240-022-1500-S						0.58	0.10
E0240-022-1750-M					1.750	44.45	5.16	131.06					0.6	0.105	E0240-022-1750-S						0.50	0.09
E0240-022-2000-M			0.022	0.56	2.000	50.80	6.07	154.18	2.07	9.21	0.19	0.85	0.5	0.088	E0240-022-2000-S	1.72	7.67	0.16	0.71	0.42	0.07	
E0240-022-2250-M					2.250	57.15	6.98	177.29					0.4	0.070	E0240-022-2250-S						0.33	0.06
E0240-022-2500-M					2.500	63.50	7.89	200.41					0.3	0.053	E0240-022-2500-S						0.25	0.04
E0240-022-2750-M					2.750	69.85	8.80	223.52					0.3	0.053	E0240-022-2750-S						0.25	0.04
E0240-026-0500-M					0.500	12.70	0.60	15.24					28.9	5.060	E0240-026-0500-S						24.07	4.22
E0240-026-0620-M					0.620	15.75	0.93	23.62					9.7	1.699	E0240-026-0620-S						8.08	1.42
E0240-026-0750-M					0.750	19.05	1.29	32.77					5.6	0.981	E0240-026-0750-S						4.66	0.82
E0240-026-0880-M					0.880	22.35	1.64	41.66					4.0	0.701	E0240-026-0880-S						3.33	0.58
E0240-026-1000-M					1.000	25.40	1.97	50.04					3.0	0.525	E0240-026-1000-S						2.50	0.44
E0240-026-1120-M					1.120	28.45	2.31	58.67					2.5	0.438	E0240-026-1120-S						2.08	0.37
E0240-026-1250-M					1.250	31.75	2.64	67.06					2.1	0.368	E0240-026-1250-S						1.75	0.31
E0240-026-1370-M					1.370	34.80	2.96	75.18					1.8	0.315	E0240-026-1370-S						1.50	0.26
E0240-026-1500-M					1.500	38.10	3.28	83.31					1.6	0.280	E0240-026-1500-S						1.33	0.23
E0240-026-1750-M			0.026	0.66	1.750	44.45	3.95	100.33	3.30	14.68	0.30	1.33	1.3	0.228	E0240-026-1750-S	2.75	12.23	0.25	1.11	1.08	0.19	
E0240-026-2000-M					2.000	50.80	4.60	116.84					1.1	0.193	E0240-026-2000-S						0.92	0.16
E0240-026-2250-M					2.250	57.15	5.38	136.65					1.0	0.175	E0240-026-2250-S						0.83	0.15
E0240-026-2500-M					2.500	63.50	6.06	153.92					0.8	0.140	E0240-026-2500-S						0.67	0.12
E0240-026-2750-M					2.750	69.85	6.74	171.20					0.8	0.140	E0240-026-2750-S						0.67	0.12
E0240-026-3000-M					3.000	76.20	7.42	188.47					0.7	0.123	E0240-026-3000-S						0.58	0.10
E0240-026-3500-M					3.500	88.90	8.76	222.50					0.6	0.105	E0240-026-3500-S						0.50	0.09
E0240-026-4000-M					4.000	101.60	10.14	257.56					0.5	0.088	E0240-026-4000-S						0.42	0.07
E0240-026-4500-M					4.500	114.30	11.49	291.85					0.4	0.070	E0240-026-4500-S						0.33	0.06
E0240-026-5000-M					5.000	127.00	12.86	326.64					0.4	0.070	E0240-026-5000-S						0.33	0.06
E0240-029-0620-M					0.620	15.75	0.87	22.10					16.5	2.890	E0240-029-0620-S						13.74	2.41
E0240-029-0750-M					0.750	19.05	1.17	29.72					9.8	1.716	E0240-029-0750-S						8.16	1.43
E0240-029-0880-M					0.880	22.35	1.47	37.34					7.0	1.226	E0240-029-0880-S						5.83	1.02
E0240-029-1000-M	0.240	6.10			1.000	25.40	1.74	44.20					5.5	0.963	E0240-029-1000-S						4.58	0.80
E0240-029-1120-M					1.120	28.45	2.02	51.31					4.5	0.788	E0240-029-1120-S						3.75	0.66
E0240-029-1250-M					1.250	31.75	2.32	58.93					3.8	0.665	E0240-029-1250-S						3.17	0.55
E0240-029-1370-M					1.370	34.80	2.59	65.79					3.3	0.578	E0240-029-1370-S						2.75	0.48
E0240-029-1500-M					1.500	38.10	2.89	73.41					2.9	0.508	E0240-029-1500-S						2.42	0.42
E0240-029-1750-M					1.750	44.45	3.47	88.14					2.4	0.420	E0240-029-1750-S						2.00	0.35
E0240-029-2000-M			0.029	0.74	2.000	50.80	4.04	102.62	4.50	20.02	0.40	1.78	2.0	0.350	E0240-029-2000-S	3.75	16.68	0.33	1.48	1.67	0.29	
E0240-029-2250-M					2.250	57.15	4.62	117.35					1.7	0.298	E0240-029-2250-S						1.42	0.25
E0240-029-2500-M					2.500	63.50	5.19	131.83					1.5	0.263	E0240-029-2500-S						1.25	0.22
E0240-029-2750-M					2.750	69.85	5.77	146.56					1.4	0.245	E0240-029-2750-S						1.17	0.20
E0240-029-3000-M					3.000	76.20	6.34	161.04					1.2	0.210	E0240-029-3000-S						1.00	0.18
E0240-029-3500-M					3.500	88.90	7.51	190.75					1.0	0.175	E0240-029-3500-S						0.83	0.15
E0240-029-4000-M					4.000	101.60	8.65	219.71					0.9	0.158	E0240-029-4000-S						0.75	0.13
E0240-029-4500-M					4.500	114.30	9.82	249.43					0.8	0.140	E0240-029-4500-S						0.67	0.12
E0240-029-5000-M					5.000	127.00	10.96	278.38					0.7	0.123	E0240-029-5000-S						0.58	0.10
E0240-031-0620-M					0.620	15.75	0.84	21.34					22.8	3.990	E0240-031-0620-S						18.99	3.32
E0240-031-0750-M					0.750	19.05	1.11	28.19					13.8	2.420	E0240-031-0750-S						11.50	2.02
E0240-031-0880-M					0.880	22.35	1.38	35.05					9.9	1.734	E0240-031-0880-S						8.25	1.44
E0240-031-1000-M					1.000	25.40	1.64	41.66					7.5	1.313	E0240-031-1000-S						6.25	1.09
E0240-031-1120-M					1.120	28.45	1.89	48.01					6.5	1.138	E0240-031-1120-S						5.41	0.95
E0240-031-1250-M					1.250	31.75	2.14	54.36					5.3	0.928	E0240-031-1250-S						4.41	0.77
E0240-031-1370-M					1.370	34.80	2.36	59.94					4.8	0.841	E0240-031-1370-S						4.00	0.70
E0240-031-1500-M					1.500	38.10	2.64	67.06					4.2	0.736	E0240-031-1500-S						3.50	0.61
E0240-031-1750-M			0.031	0.79	1.750	44.45	3.15	80.01	5.30	23.58	0.50	2.22	3.4	0.595	E0240-031-1750-S	4.42	19.64	0.42	1.85	2.83	0.50	
E0240-031-2000-M					2.000	50.80	3.65	92.71					2.9	0.508	E0240-031-2000-S						2.42	0.42
E0240-031-2250-M					2.250	57.15	4.16	105.66					2.5	0.438	E0240-031-2250-S						2.08	0.37
E0240-031-2500-M					2.500	63.50	4.66	118.36					2.2	0.385	E0240-031-2500-S						1.83	0.32
E0240-031-2750-M					2.750	69.85	5.29	134.37					1.9	0.333	E0240-031-2750-S						1.58	0.28
E0240-031-3000-M					3.000	76.20	5.81	147.57					1.7	0.298	E0240-031-3000-S						1.42	0.25
E0240-031-3500-M					3.500	88.90	6.78	172.21					1.5	0.263	E0240-031-3500-S						1.25	0.22
E0240-031-4000-M					4.000	101.60	7.81	198.37					1.3	0.228	E0240-031-4000-S						1.08	0.19
E0240-031-4500-M					4.500	114.30	8.84	224.54					1.1	0.193	E0240-031-4500-S						0.92	0.16

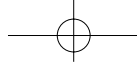

MUSIC WIRE 乐器金属弦线												STAINLESS STEEL 不锈钢金属线											
Catalog Number 编号	Outside Diameter (OD) 外径 (OD)		Wire Diameter (d) 线径 (d)		Free Length L, Approx 自由长度L (估算值)		Ext. L ₁ 拉伸长度L ₁		Load P at L ₁ L ₁ 下的承载 载荷P		Initial Tension T (Ref. only) 初始张力T (仅供参考)		Spring Rate R 弹性系数R		Catalog Number 编号	Load P at L ₁ L ₁ 下的承载 载荷P		Initial Tension T (Ref. only) 初始张力T (仅供参考)		Spring Rate R 弹性系数R			
	in	mm	in	mm	in	mm	in	mm	lb	N	lb	N	lb/in	N/mm		lb	N	lb	N	lb/in	N/mm		
E0240-031-5000-M			0.031	0.79	5.000	127.00	9.87	250.70			9.87	2.22	1.0	0.175	E0240-031-5000-S								
E0240-034-0620-M					0.620	15.75	0.80	20.32					36.0	6.300	E0240-034-0620-S								
E0240-034-0750-M					0.750	19.05	1.04	26.42					22.1	3.870	E0240-034-0750-S								
E0240-034-0880-M					0.880	22.35	1.26	32.00					16.0	2.800	E0240-034-0880-S								
E0240-034-1000-M					1.000	25.40	1.50	38.10					12.7	2.220	E0240-034-1000-S								
E0240-034-1120-M					1.120	28.45	1.72	43.69					10.6	1.856	E0240-034-1120-S								
E0240-034-1250-M					1.250	31.75	1.96	49.78					8.9	1.559	E0240-034-1250-S								
E0240-034-1370-M					1.370	34.80	2.18	55.37					7.8	1.366	E0240-034-1370-S								
E0240-034-1500-M					1.500	38.10	2.42	61.47					6.9	1.208	E0240-034-1500-S								
E0240-034-1750-M			0.034	0.86	1.750	44.45	2.89	73.41	7.00	31.14	0.65	2.89	5.6	0.981	E0240-034-1750-S	5.83	25.94	0.54	2.41				
E0240-034-2000-M					2.000	50.80	3.35	85.09					4.7	0.823	E0240-034-2000-S								
E0240-034-2250-M					2.250	57.15	3.81	96.77					4.1	0.718	E0240-034-2250-S								
E0240-034-2500-M					2.500	63.50	4.27	108.46					3.6	0.630	E0240-034-2500-S								
E0240-034-2750-M					2.750	69.85	4.74	120.40					3.2	0.560	E0240-034-2750-S								
E0240-034-3000-M					3.000	76.20	5.20	132.08					2.9	0.508	E0240-034-3000-S								
E0240-034-3500-M					3.500	88.90	6.13	155.70					2.4	0.420	E0240-034-3500-S								
E0240-034-4000-M					4.000	101.60	7.05	179.07					2.1	0.368	E0240-034-4000-S								
E0240-034-4500-M					4.500	114.30	7.97	202.44					1.8	0.315	E0240-034-4500-S								
E0240-034-5000-M					5.000	127.00	8.90	226.06					1.6	0.280	E0240-034-5000-S								
E0240-037-0620-M					0.620	15.75	0.77	19.56					54.7	9.580	E0240-037-0620-S								
E0240-037-0750-M					0.750	19.05	0.98	24.89					34.3	6.010	E0240-037-0750-S								
E0240-037-1000-M					1.000	25.40	1.40	35.56					19.8	3.470	E0240-037-1000-S								
E0240-037-1120-M					1.120	28.45	1.61	40.89					16.4	2.870	E0240-037-1120-S								
E0240-037-1250-M					1.250	31.75	1.81	45.97					14.0	2.450	E0240-037-1250-S								
E0240-037-1370-M	0.240	6.10			1.370	34.80	2.01	51.05					12.4	2.170	E0240-037-1370-S								
E0240-037-1500-M					1.500	38.10	2.20	55.88					11.2	1.961	E0240-037-1500-S								
E0240-037-1750-M					1.750	44.45	2.63	66.80					8.9	1.559	E0240-037-1750-S								
E0240-037-2000-M			0.037	0.94	2.000	50.80	3.04	77.22	8.70	38.70	0.80	3.56	7.6	1.331	E0240-037-2000-S	7.25	32.24	0.67	2.97				
E0240-037-2250-M					2.250	57.15	3.45	87.63					6.5	1.138	E0240-037-2250-S								
E0240-037-2500-M					2.500	63.50	3.85	97.79					5.8	1.016	E0240-037-2500-S								
E0240-037-2750-M					2.750	69.85	4.27	108.46					5.2	0.911	E0240-037-2750-S								
E0240-037-3000-M					3.000	76.20	4.67	118.62					4.7	0.823	E0240-037-3000-S								
E0240-037-3250-M					3.250	82.55	5.16	131.06					4.2	0.736	E0240-037-3250-S								
E0240-037-3500-M					3.500	88.90	5.58	141.73					3.8	0.665	E0240-037-3500-S								
E0240-037-4000-M					4.000	101.60	6.38	162.05					3.3	0.578	E0240-037-4000-S								
E0240-037-4500-M					4.500	114.30	7.22	183.39					2.9	0.508	E0240-037-4500-S								
E0240-037-5000-M					5.000	127.00	8.05	204.47					2.6	0.455	E0240-037-5000-S								
E0240-041-0750-M					0.750	19.05	0.93	23.62					58.5	10.240	E0240-041-0750-S								
E0240-041-1000-M					1.000	25.40	1.31	33.27					34.6	6.060	E0240-041-1000-S								
E0240-041-1120-M					1.120	28.45	1.49	37.85					28.9	5.060	E0240-041-1120-S								
E0240-041-1250-M					1.250	31.75	1.68	42.67					24.5	4.290	E0240-041-1250-S								
E0240-041-1370-M					1.370	34.80	1.86	47.24					21.5	3.770	E0240-041-1370-S								
E0240-041-1500-M					1.500	38.10	2.06	52.32					19.0	3.330	E0240-041-1500-S								
E0240-041-1750-M					1.750	44.45	2.43	61.72					15.5	2.710	E0240-041-1750-S								
E0240-041-2000-M			0.041	1.04	2.000	50.80	2.81	71.37	11.65	51.82	1.05	4.67	13.1	2.290	E0240-041-2000-S	9.70	43.17	0.87	3.89				
E0240-041-2250-M					2.250	57.15	3.18	80.77					11.4	1.996	E0240-041-2250-S								
E0240-041-2500-M					2.500	63.50	3.56	90.42					10.0	1.751	E0240-041-2500-S								
E0240-041-2750-M					2.750	69.85	3.94	100.08					8.9	1.559	E0240-041-2750-S								
E0240-041-3000-M					3.000	76.20	4.31	109.47					8.1	1.419	E0240-041-3000-S								
E0240-041-3500-M					3.500	88.90	5.06	128.52					6.8	1.191	E0240-041-3500-S								
E0240-041-4000-M					4.000	101.60	5.81	147.57					5.9	1.033	E0240-041-4000-S								
E0240-041-4500-M					4.500	114.30	6.57	166.88					5.1	0.893	E0240-041-4500-S								
E0240-041-5000-M					5.000	127.00	7.31	185.67					4.6	0.806	E0240-041-5000-S								
T31450					0.673	17.10	0.966	24.53					24.1	4.230	T41450								
T31460	0.248	6.30	0.035	0.90	0.886	22.50	1.354	34.40	8.34	37.10	1.25	5.58	15.1	2.650	T41460	6.95	30.90	1.05	4.65				
T31470					1.205	30.60	1.937	49.20					9.7	1.700	T41470								
T31480					1.736	44.10	2.906	73.80					6.1	1.060	T41480								
T31120					0.634	16.10	1.287	32.70					3.5	0.620	T41120								
T31130	0.276	7.00	0.025	0.63	0.783	19.90	1.831	46.50	2.74	12.20	0.38	1.67	2.2	0.390	T41130	2.29	10.16	0.31	1.39				
T31140					1.008	25.60	2.646	67.20					1.4	0.250	T41140								
T31150					1.378	35.00	3.996	101.50					0.9	0.160	T41150								

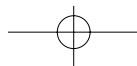

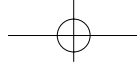

MUSIC WIRE 乐器金属弦线												STAINLESS STEEL 不锈钢金属线											
Catalog Number 编号	Outside Diameter (OD) 外径 (OD)		Wire Diameter (d) 线径 (d)		Free Length L, Approx 自由长度L (估算值)		Ext. L ₁ 拉伸长度L ₁		Load P at L ₁ L ₁ 下的承载 载荷P		Initial Tension T (Ref. only) 初始张力T (仅供参考)		Spring Rate R 弹性系数R		Catalog Number 编号	Load P at L ₁ L ₁ 下的承载 载荷P		Initial Tension T (Ref. only) 初始张力T (仅供参考)		Spring Rate R 弹性系数R			
	in	mm	in	mm	in	mm	in	mm	lb	N	lb	N	lb/in	N/mm		lb	N	lb	N	lb/in	N/mm		
T31160			0.025	0.63	1.874	47.60	5.799	147.30	2.74	12.20	0.38	1.67	0.6	0.110	T41160	2.29	10.16	0.31	1.39	0.50	0.09		
T31570					0.748	19.00	1.070	27.17					26.9	4.710	T41570					22.41	3.92		
T31580					0.984	25.00	1.500	38.10					16.8	2.940	T41580					13.99	2.45		
T31590			0.039	1.00	1.339	34.00	2.142	54.40	10.18	45.30	1.52	6.78	10.4	1.830	T41590	8.48	37.73	1.27	5.66	8.66	1.52		
T31600	0.276	7.00			1.929	49.00	3.217	81.70					6.7	1.180	T41600					5.58	0.98		
T31610					11.417	290.00	20.079	510.00					1.0	0.180	T41610					0.83	0.15		
T31920					0.870	22.10	1.042	26.46					127.3	22.300	T41920					106.04	18.58		
T31930			0.055	1.40	1.201	30.50	1.476	37.48	25.63	114.00	3.79	16.88	79.4	13.900	T41930	21.35	94.96	3.16	14.06	66.14	11.58		
T31940					1.697	43.10	2.126	54.00					50.9	8.910	T41940					42.40	7.42		
T31240					0.689	17.50	1.354	34.40					4.5	0.780	T41240					3.75	0.65		
T31250					0.854	21.70	1.917	48.70					2.8	0.490	T41250					2.33	0.41		
T31260			0.028	0.70	1.102	28.00	2.764	70.20	3.46	15.40	0.49	2.18	1.8	0.310	T41260	2.88	12.83	0.41	1.81	1.50	0.26		
T31270					1.516	38.50	4.173	106.00					1.1	0.200	T41270					0.92	0.17		
T31280	0.295	7.50			2.067	52.50	6.043	153.50					0.7	0.130	T41280					0.58	0.11		
T31700					0.811	20.60	1.138	28.90					32.5	5.690	T41700					27.07	4.74		
T31710			0.043	1.10	1.071	27.20	1.594	40.50	12.48	55.50	1.85	8.25	20.3	3.550	T41710	10.39	46.23	1.54	6.87	16.91	2.96		
T31720					1.461	37.10	2.280	57.90					13.0	2.280	T41720					10.83	1.90		
T31730					2.110	53.60	3.417	86.80					8.1	1.420	T41730					6.75	1.18		
E0300-031-1000-M					1.000	25.40	1.84	46.74					4.7	0.823	E0300-031-1000-S					3.92	0.69		
E0300-031-1120-M					1.120	28.45	2.19	55.63					3.7	0.648	E0300-031-1120-S					3.08	0.54		
E0300-031-1250-M					1.250	31.75	2.56	65.02					3.0	0.525	E0300-031-1250-S					2.50	0.44		
E0300-031-1370-M					1.370	34.80	2.91	73.91					2.6	0.455	E0300-031-1370-S					2.17	0.38		
E0300-031-1500-M					1.500	38.10	3.29	83.57					2.2	0.385	E0300-031-1500-S					1.83	0.32		
E0300-031-1750-M			0.031	0.79	1.750	44.45	4.01	101.85	4.39	19.53	0.39	1.73	1.8	0.315	E0300-031-1750-S	3.66	16.27	0.32	1.44	1.50	0.26		
E0300-031-2000-M					2.000	50.80	4.73	120.14					1.5	0.263	E0300-031-2000-S					1.25	0.22		
E0300-031-2250-M					2.250	57.15	5.45	138.43					1.2	0.210	E0300-031-2250-S					1.00	0.18		
E0300-031-2500-M					2.500	63.50	6.17	156.72					1.1	0.193	E0300-031-2500-S					0.92	0.16		
E0300-031-2750-M					2.750	69.85	6.90	175.26					1.0	0.175	E0300-031-2750-S					0.83	0.15		
E0300-031-3000-M					3.000	76.20	7.62	193.55					0.9	0.158	E0300-031-3000-S					0.75	0.13		
E0300-037-0750-M					0.750	19.05	1.01	25.65					25.4	4.450	E0300-037-0750-S					21.16	3.71		
E0300-037-1000-M					1.000	25.40	1.56	39.62					11.8	2.070	E0300-037-1000-S					9.83	1.72		
E0300-037-1120-M					1.120	28.45	1.82	46.23					9.4	1.646	E0300-037-1120-S					7.83	1.37		
E0300-037-1250-M					1.250	31.75	2.10	53.34					7.7	1.348	E0300-037-1250-S					6.41	1.12		
E0300-037-1370-M					1.370	34.80	2.37	60.20					6.6	1.156	E0300-037-1370-S					5.50	0.96		
E0300-037-1500-M			0.037	0.94	1.500	38.10	2.65	67.31	7.20	32.03	0.65	2.89	5.7	0.998	E0300-037-1500-S	6.00	26.68	0.54	2.41	4.75	0.83		
E0300-037-1750-M					1.750	44.45	3.20	81.28					4.5	0.788	E0300-037-1750-S					3.75	0.66		
E0300-037-2000-M					2.000	50.80	3.75	95.25					3.7	0.648	E0300-037-2000-S					3.08	0.54		
E0300-037-2250-M					2.250	57.15	4.30	109.22					3.2	0.560	E0300-037-2250-S					2.67	0.47		
E0300-037-2500-M	0.300	7.62			2.500	63.50	4.85	123.19					2.8	0.490	E0300-037-2500-S					2.33	0.41		
E0300-037-2750-M					2.750	69.85	5.40	137.16					2.5	0.438	E0300-037-2750-S					2.08	0.37		
E0300-037-3000-M					3.000	76.20	5.94	150.88					2.2	0.385	E0300-037-3000-S					1.83	0.32		
E0300-049-1000-M					1.000	25.40	1.28	32.51					50.7	8.880	E0300-049-1000-S					42.23	7.40		
E0300-049-1120-M					1.120	28.45	1.47	37.34					41.0	7.180	E0300-049-1120-S					34.15	5.98		
E0300-049-1250-M					1.250	31.75	1.67	42.42					33.9	5.940	E0300-049-1250-S					28.24	4.95		
E0300-049-1370-M					1.370	34.80	1.85	46.99					29.3	5.130	E0300-049-1370-S					24.41	4.27		
E0300-049-1500-M					1.500	38.10	2.06	52.32					25.5	4.470	E0300-049-1500-S					21.24	3.72		
E0300-049-1750-M			0.049	1.24	1.750	44.45	2.44	61.98	15.60	69.39	1.40	6.23	20.4	3.570	E0300-049-1750-S	13.00	57.80	1.17	5.19	16.99	2.97		
E0300-049-2000-M					2.000	50.80	2.83	71.88					17.0	2.980	E0300-049-2000-S					14.16	2.48		
E0300-049-2250-M					2.250	57.15	3.22	81.79					14.6	2.560	E0300-049-2250-S					12.16	2.13		
E0300-049-2500-M					2.500	63.50	3.61	91.69					12.8	2.240	E0300-049-2500-S					10.66	1.87		
E0300-049-2750-M					2.750	69.85	4.00	101.60					11.4	1.996	E0300-049-2750-S					9.50	1.66		
E0300-049-3000-M					3.000	76.20	4.38	111.25					10.2	1.786	E0300-049-3000-S					8.50	1.49		
E0300-055-1000-M					1.000	25.40	1.21	30.73					93.3	16.340	E0300-055-1000-S					77.72	13.61		
E0300-055-1120-M					1.120	28.45	1.38	35.05					76.0	13.310	E0300-055-1120-S					63.31	11.09		
E0300-055-1250-M					1.250	31.75	1.56	39.62					63.3	11.090	E0300-055-1250-S					52.73	9.24		
E0300-055-1370-M					1.370	34.80	1.72	43.69					54.8	9.600	E0300-055-1370-S					45.65	8.00		
E0300-055-1500-M			0.055	1.40	1.500	38.10	1.90	48.26	21.31	94.79	1.92	8.54	47.9	8.390	E0300-055-1500-S	17.75	78.96	1.60	7.11	39.90	6.99		
E0300-055-1750-M					1.750	44.45	2.25	57.15					38.5	6.740	E0300-055-1750-S					32.07	5.61		
E0300-055-2000-M					2.000	50.80	2.60	66.04					32.2	5.640	E0300-055-2000-S					26.82	4.70		
E0300-055-2250-M					2.250	57.15	2.95	74.93					27.7	4.850	E0300-055-2250-S					23.07	4.04		
E0300-055-2500-M																							

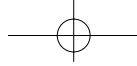

MUSIC WIRE 乐器金属弦线												STAINLESS STEEL 不锈钢金属线											
Catalog Number 编号	Outside Diameter (OD) 外径 (OD)		Wire Diameter (d) 线径 (d)		Free Length L, Approx 自由长度L (估算值)		Ext. L ₁ 拉伸长度 L ₁		Load P at L ₁ L ₁ 下的承载 载荷P		Initial Tension T (Ref. only) 初始张力T (仅供参考)		Spring Rate R 弹性系数 R		Catalog Number 编号	Load P at L ₁ L ₁ 下的承载 载荷P		Initial Tension T (Ref. only) 初始张力T (仅供参考)		Spring Rate R 弹性系数 R			
	in	mm	in	mm	in	mm	in	mm	lb	N	lb	N	lb/in	N/mm		lb	N	lb	N	lb/in	N/mm		
E0300-055-2750-M	0.300	7.62	0.055	1.40	2.750	69.85	3.65	92.71	21.31	94.79	1.92	8.54	21.6	3.780	E0300-055-2750-S	17.75	78.96	1.60	7.11	17.99	3.15		
E0300-055-3000-M					3.000	76.20	4.00	101.60					19.5	3.410	E0300-055-3000-S					16.24	2.84		
T32050					0.996	25.30	1.188	30.18					145.0	25.400	T42050					120.79	21.16		
T32060	0.315	8.00	0.063	1.60	1.374	34.90	1.681	42.71	32.82	146.00	4.90	21.81	90.8	15.900	T42060	27.34	121.62	4.09	18.17	75.64	13.25		
T32070					1.941	49.30	2.421	61.50					58.2	10.200	T42070					48.48	8.50		
T31820					0.906	23.00	1.293	32.85					31.0	5.430	T41820					25.82	4.52		
T31830					1.189	30.20	1.811	46.00					19.4	3.390	T41830					16.16	2.82		
T31840	0.335	8.50	0.047	1.20	1.614	41.00	2.583	65.60	14.12	62.80	2.07	9.22	12.4	2.170	T41840	11.76	52.31	1.73	7.68	10.33	1.81		
T31850					2.323	59.00	3.882	98.60					7.7	1.350	T41850					6.41	1.13		
T31860					11.417	290.00	20.276	515.00					1.37	0.240	T41860					1.14	0.20		
T31370					0.811	20.60	1.654	42.00					4.4	0.760	T41370					3.67	0.63		
T31380					1.000	25.40	2.350	59.70					2.7	0.470	T41380					2.25	0.39		
T31390			0.031	0.80	1.283	32.60	3.390	86.10	4.27	19.00	0.61	2.72	1.7	0.300	T41390	3.56	15.83	0.51	2.27	1.42	0.25		
T31400	0.354	9.00			1.756	44.60	5.126	130.20					1.1	0.190	T41400					0.92	0.16		
T31410					2.386	60.60	7.425	188.60					0.74	0.130	T41410					0.62	0.11		
T32170					1.118	28.40	1.330	33.77					163.3	28.600	T42170					136.03	23.82		
T32180			0.071	1.80	1.543	39.20	1.881	47.79	40.46	180.00	5.95	26.47	101.6	17.800	T42180	33.71	149.94	4.96	22.05	84.63	14.83		
T32190					2.181	55.40	2.709	68.80					65.7	11.500	T42190					54.73	9.58		
E0360-026-1000-M					1.000	25.40	2.32	58.93					1.5	0.263	E0360-026-1000-S					1.25	0.22		
E0360-026-1120-M					1.120	28.45	2.98	75.69					1.1	0.193	E0360-026-1120-S					0.92	0.16		
E0360-026-1250-M			0.026	0.66	1.250	31.75	3.69	93.73	2.25	10.01	0.20	0.89	0.8	0.140	E0360-026-1250-S	1.87	8.34	0.17	0.74	0.67	0.12		
E0360-026-1370-M					1.370	34.80	4.34	110.24					0.7	0.123	E0360-026-1370-S					0.58	0.10		
E0360-026-1500-M					1.500	38.10	5.05	128.27					0.6	0.105	E0360-026-1500-S					0.50	0.09		
E0360-026-1750-M					1.750	44.45	6.42	163.07					0.4	0.070	E0360-026-1750-S					0.33	0.06		
E0360-031-0880-M					0.870	22.10	1.40	35.56					6.3	1.103	E0360-031-0880-S					5.25	0.92		
E0360-031-1000-M					1.000	25.40	2.02	51.31					3.2	0.560	E0360-031-1000-S					2.67	0.47		
E0360-031-1120-M					1.120	28.45	2.48	62.99					2.4	0.420	E0360-031-1120-S					2.00	0.35		
E0360-031-1250-M					1.250	31.75	2.95	74.93					1.9	0.333	E0360-031-1250-S					1.58	0.28		
E0360-031-1370-M					1.370	34.80	3.41	86.61					1.6	0.280	E0360-031-1370-S					1.33	0.23		
E0360-031-1500-M			0.031	0.79	1.500	38.10	3.81	96.77	3.69	16.41	0.33	1.47	1.4	0.245	E0360-031-1500-S	3.07	13.67	0.28	1.22	1.17	0.20		
E0360-031-1750-M					1.750	44.45	4.84	122.94					1.1	0.193	E0360-031-1750-S					0.92	0.16		
E0360-031-2000-M					2.000	50.80	5.82	147.83					0.9	0.158	E0360-031-2000-S					0.75	0.13		
E0360-031-2250-M					2.250	57.15	6.79	172.47					0.7	0.123	E0360-031-2250-S					0.58	0.10		
E0360-031-2500-M					2.500	63.50	7.77	197.36					0.6	0.105	E0360-031-2500-S					0.50	0.09		
E0360-031-2750-M					2.750	69.85	8.75	222.25					0.6	0.105	E0360-031-2750-S					0.50	0.09		
E0360-031-3000-M					3.000	76.20	9.72	246.89					0.5	0.088	E0360-031-3000-S					0.42	0.07		
E0360-034-1000-M					1.000	25.40	1.75	44.45					5.8	1.016	E0360-034-1000-S					4.83	0.85		
E0360-034-1120-M					1.120	28.45	2.14	54.36					4.2	0.736	E0360-034-1120-S					3.50	0.61		
E0360-034-1250-M					1.250	31.75	2.57	65.28					3.3	0.578	E0360-034-1250-S					2.75	0.48		
E0360-034-1370-M	0.360	9.14			1.370	34.80	2.97	75.44					2.7	0.473	E0360-034-1370-S					2.25	0.39		
E0360-034-1500-M					1.500	38.10	3.40	86.36					2.3	0.403	E0360-034-1500-S					1.92	0.34		
E0360-034-1750-M					1.750	44.45	4.23	107.44					1.8	0.315	E0360-034-1750-S					1.50	0.26		
E0360-034-2000-M					2.000	50.80	5.06	128.52					1.4	0.245	E0360-034-2000-S					1.17	0.20		
E0360-034-2250-M			0.034	0.86	2.250	57.15	5.90	149.86	4.78	21.26	0.43	1.91	1.2	0.210	E0360-034-2250-S	3.98	17.71	0.36	1.59	1.00	0.18		
E0360-034-2500-M					2.500	63.50	6.70	170.18					1.0	0.175	E0360-034-2500-S					0.83	0.15		
E0360-034-2750-M					2.750	69.85	7.54	191.52					0.9	0.158	E0360-034-2750-S					0.75	0.13		
E0360-034-3000-M					3.000	76.20	8.37	212.60					0.8	0.140	E0360-034-3000-S					0.67	0.12		
E0360-034-3500-M					3.500	88.90	10.01	254.25					0.7	0.123	E0360-034-3500-S					0.58	0.10		
E0360-034-4000-M					4.000	101.60	11.69	296.93					0.6	0.105	E0360-034-4000-S					0.50	0.09		
E0360-034-4500-M					4.500	114.30	13.33	338.58					0.5	0.088	E0360-034-4500-S					0.42	0.07		
E0360-034-5000-M					5.000	127.00	14.96	379.98					0.4	0.070	E0360-034-5000-S					0.33	0.06		
E0360-037-0750-M					0.750	19.05	0.91	23.11					35.3	6.180	E0360-037-0750-S					29.40	5.15		
E0360-037-1000-M					1.000	25.40	1.68	42.67					7.9	1.384	E0360-037-1000-S					6.58	1.15		
E0360-037-1120-M					1.120	28.45	2.04	51.82					5.9	1.033	E0360-037-1120-S					4.91	0.86		
E0360-037-1250-M					1.250	31.75	2.39	60.71					4.7	0.823	E0360-037-1250-S					3.92	0.69		
E0360-037-1370-M			0.037	0.94	1.370	34.80	2.71	68.83	5.90	26.24	0.50	2.22	4.0	0.701	E0360-037-1370-S	4.92	21.86	0.42	1.85	3.33	0.58		
E0360-037-1500-M					1.500	38.10	3.06	77.72					3.4	0.595	E0360-037-1500-S					2.83	0.50		
E0360-037-1750-M					1.750	44.45	3.77	95.76					2.6	0.455	E0360-037-1750-S					2.17	0.38		
E0360-037-2000-M					2.000	50.80	4.44	112.78					2.2	0.385	E0360-037-2000-S					1.83	0.32		
E0360-037-2250-M					2.250	57.15	5.14	130.56					1.8	0.315	E0360-037-2250-S					1.50	0.26		

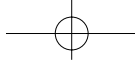

MUSIC WIRE 乐器金属弦线											STAINLESS STEEL 不锈钢金属线												
Catalog Number 编号	Outside Diameter (OD) 外径 (OD)		Wire Diameter (d) 线径 (d)		Free Length L, Approx 自由长度L (估算值)		Ext. L _i 拉伸长度 L _i		Load P at L _i L _i 下的承载 载荷P		Initial Tension T (Ref. only) 初始张力T (仅供参考)		Spring Rate R 弹性系数 R		Catalog Number 编号	Load P at L _i L _i 下的承载 载荷P		Initial Tension T (Ref. only) 初始张力T (仅供参考)		Spring Rate R 弹性系数 R			
	in	mm	in	mm	in	mm	in	mm	lb	N	lb	N	lb/in	N/mm		lb	N	lb	N	lb/in	N/mm		
E0360-037-2750-M					2.750	69.85	6.64	168.66					1.4	0.245	E0360-037-2750-S							1.17	0.20
E0360-037-3000-M					3.000	76.20	7.35	186.69					1.3	0.228	E0360-037-3000-S							1.08	0.19
E0360-037-3500-M			0.037	0.94	3.500	88.90	8.67	220.22	5.90	26.24	0.50	2.22	1.0	0.175	E0360-037-3500-S	4.92	21.86	0.42	1.85		0.83	0.15	
E0360-037-4000-M					4.000	101.60	10.08	256.03					0.9	0.158	E0360-037-4000-S						0.75	0.13	
E0360-037-4500-M					4.500	114.30	11.49	291.85					0.8	0.140	E0360-037-4500-S						0.67	0.12	
E0360-037-5000-M					5.000	127.00	12.90	327.66					0.7	0.123	E0360-037-5000-S						0.58	0.10	
E0360-039-1000-M					1.000	25.40	1.56	39.62					11.5	2.010	E0360-039-1000-S						9.58	1.67	
E0360-039-1120-M					1.120	28.45	1.87	47.50					8.5	1.489	E0360-039-1120-S						7.08	1.24	
E0360-039-1250-M					1.250	31.75	2.21	56.13					6.6	1.156	E0360-039-1250-S						5.50	0.96	
E0360-039-1370-M					1.370	34.80	2.53	64.26					5.5	0.963	E0360-039-1370-S						4.58	0.80	
E0360-039-1500-M					1.500	38.10	2.87	72.90					4.7	0.823	E0360-039-1500-S						3.92	0.69	
E0360-039-1750-M			0.039	0.99	1.750	44.45	3.53	89.66	7.02	31.23	0.63	2.80	3.6	0.630	E0360-039-1750-S	5.85	26.01	0.52	2.33		3.00	0.53	
E0360-039-2000-M					2.000	50.80	4.19	106.43					2.9	0.508	E0360-039-2000-S						2.42	0.42	
E0360-039-2250-M					2.250	57.15	4.84	122.94					2.5	0.438	E0360-039-2250-S						2.08	0.37	
E0360-039-2500-M					2.500	63.50	5.50	139.70					2.1	0.368	E0360-039-2500-S						1.75	0.31	
E0360-039-2750-M					2.750	69.85	6.16	156.46					1.9	0.333	E0360-039-2750-S						1.58	0.28	
E0360-039-3000-M					3.000	76.20	6.82	173.23					1.7	0.298	E0360-039-3000-S						1.42	0.25	
E0360-041-0750-M					0.750	19.05	0.89	22.61					52.7	9.230	E0360-041-0750-S						43.90	7.69	
E0360-041-1000-M					1.000	25.40	1.55	39.37					12.9	2.260	E0360-041-1000-S						10.75	1.88	
E0360-041-1120-M					1.120	28.45	1.85	46.99					9.9	1.734	E0360-041-1120-S						8.25	1.44	
E0360-041-1250-M					1.250	31.75	2.14	54.36					8.1	1.419	E0360-041-1250-S						6.75	1.18	
E0360-041-1370-M					1.370	34.80	2.43	61.72					6.8	1.191	E0360-041-1370-S						5.66	0.99	
E0360-041-1500-M					1.500	38.10	2.72	69.09					5.9	1.033	E0360-041-1500-S						4.91	0.86	
E0360-041-1750-M					1.750	44.45	3.30	83.82					4.6	0.806	E0360-041-1750-S						3.83	0.67	
E0360-041-2000-M			0.041	1.04	2.000	50.80	3.89	98.81	7.90	35.14	0.70	3.11	3.8	0.665	E0360-041-2000-S	6.58	29.27	0.58	2.59		3.17	0.55	
E0360-041-2250-M					2.250	57.15	4.50	114.30					3.2	0.560	E0360-041-2250-S						2.67	0.47	
E0360-041-2500-M					2.500	63.50	5.08	129.03					2.7	0.473	E0360-041-2500-S						2.25	0.39	
E0360-041-2750-M					2.750	69.85	5.75	146.05					2.4	0.420	E0360-041-2750-S						2.00	0.35	
E0360-041-3000-M	0.360	9.14			3.000	76.20	6.36	161.54					2.2	0.385	E0360-041-3000-S						1.83	0.32	
E0360-041-3500-M					3.500	88.90	7.58	192.53					1.8	0.315	E0360-041-3500-S						1.50	0.26	
E0360-041-4000-M					4.000	101.60	8.69	220.73					1.5	0.263	E0360-041-4000-S						1.25	0.22	
E0360-041-4500-M					4.500	114.30	9.91	251.71					1.3	0.228	E0360-041-4500-S						1.08	0.19	
E0360-041-5000-M					5.000	127.00	11.10	281.94					1.2	0.210	E0360-041-5000-S						1.00	0.18	
E0360-045-0750-M					0.750	19.05	0.87	22.10					76.5	13.400	E0360-045-0750-S						63.72	11.16	
E0360-045-1000-M					1.000	25.40	1.43	36.32					21.8	3.820	E0360-045-1000-S						18.16	3.18	
E0360-045-1120-M					1.120	28.45	1.69	42.93					16.4	2.870	E0360-045-1120-S						13.66	2.39	
E0360-045-1250-M					1.250	31.75	1.93	49.02					13.6	2.380	E0360-045-1250-S						11.33	1.98	
E0360-045-1370-M					1.370	34.80	2.20	55.88					11.2	1.961	E0360-045-1370-S						9.33	1.63	
E0360-045-1500-M					1.500	38.10	2.47	62.74					9.6	1.681	E0360-045-1500-S						8.00	1.40	
E0360-045-1750-M					1.750	44.45	2.98	75.69					7.5	1.313	E0360-045-1750-S						6.25	1.09	
E0360-045-2000-M					2.000	50.80	3.49	88.65					6.2	1.086	E0360-045-2000-S						5.16	0.91	
E0360-045-2250-M			0.045	1.14	2.250	57.15	4.00	101.60	10.20	45.37	0.90	4.00	5.3	0.928	E0360-045-2250-S	8.50	37.79	0.75	3.33		4.41	0.77	
E0360-045-2500-M					2.500	63.50	4.51	114.55					4.6	0.806	E0360-045-2500-S						3.83	0.67	
E0360-045-2750-M					2.750	69.85	5.02	127.51					4.1	0.718	E0360-045-2750-S						3.42	0.60	
E0360-045-3000-M					3.000	76.20	5.53	140.46					3.6	0.630	E0360-045-3000-S						3.00	0.53	
E0360-045-3500-M					3.500	88.90	6.71	170.43					3.0	0.525	E0360-045-3500-S						2.50	0.44	
E0360-045-4000-M					4.000	101.60	7.77	197.36					2.5	0.438	E0360-045-4000-S						2.08	0.37	
E0360-045-4500-M					4.500	114.30	8.83	224.28					2.2	0.385	E0360-045-4500-S						1.83	0.32	
E0360-045-5000-M					5.000	127.00	9.78	248.41					1.9	0.333	E0360-045-5000-S						1.58	0.28	
E0360-045-5500-M					5.500	139.70	10.83	275.08					1.7	0.298	E0360-045-5500-S						1.42	0.25	
E0360-045-6000-M					6.000	152.40	11.87	301.50					1.6	0.280	E0360-045-6000-S						1.33	0.23	
E0360-049-1000-M					1.000	25.40	1.33	33.78					36.0	6.300	E0360-049-1000-S						29.99	5.25	
E0360-049-1120-M					1.120	28.45	1.56	39.62					27.3	4.780	E0360-049-1120-S						22.74	3.98	
E0360-049-1250-M					1.250	31.75	1.81	45.97					21.6	3.780	E0360-049-1250-S						17.99	3.15	
E0360-049-1370-M					1.370	34.80	2.03	51.56					18.1	3.170	E0360-049-1370-S						15.08	2.64	
E0360-049-1500-M			0.049	1.24	1.500	38.10	2.28	57.91	13.20	58.72	1.20	5.34	15.4	2.700	E0360-049-1500-S	11.00	48.91	1.00	4.45		12.83	2.25	
E0360-049-1750-M					1.750	44.45	2.75	69.85					12.0	2.100	E0360-049-1750-S						10.00	1.75	
E0360-049-2000-M					2.000	50.80	3.23	82.04					9.8	1.716	E0360-049-2000-S						8.16	1.43	
E0360-049-2250-M					2.250	57.15	3.70	93.98					8.3	1.454	E0360-049-2250-S						6.91	1.21	
E0360-049-2500-M					2.500	63.50	4.17	105.92					7.2	1.261	E0360-049-2500-S						6.00	1.05	
E0360-049-2750-M					2.750	69.85	4.65	118.11					6.4	1.121	E0360-049-2750-S						5.33	0.93	

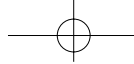

MUSIC WIRE 乐器金属弦线											STAINLESS STEEL 不锈钢金属线												
Catalog Number 编号	Outside Diameter (OD) 外径 (OD)		Wire Diameter (d) 线径 (d)		Free Length L, Approx 自由长度L (估算值)		Ext. L ₁ 拉伸长度 L ₁		Load P at L ₁ L ₁ 下的承载 载荷P		Initial Tension T (Ref. only) 初始张力T (仅供参考)		Spring Rate R 弹性系数 R		Catalog Number 编号	Load P at L ₁ L ₁ 下的承载 载荷P		Initial Tension T (Ref. only) 初始张力T (仅供参考)		Spring Rate R 弹性系数 R			
	in	mm	in	mm	in	mm	in	mm	lb	N	lb	N	lb/in	N/mm		lb	N	lb	N	lb/in	N/mm		
E0360-049-3000-M					3.000	76.20	5.12	130.05					5.7	0.998	E0360-049-3000-S							4.75	0.83
E0360-049-3500-M					3.500	88.90	6.07	154.18					4.7	0.823	E0360-049-3500-S							3.92	0.69
E0360-049-4000-M					4.000	101.60	7.01	178.05					4.0	0.701	E0360-049-4000-S							3.33	0.58
E0360-049-4500-M			0.049	1.24	4.500	114.30	7.96	202.18	13.20	58.72	1.20	5.34	3.5	0.613	E0360-049-4500-S	11.00	48.91	1.00	4.45			2.92	0.51
E0360-049-5000-M					5.000	127.00	8.90	226.06					3.1	0.543	E0360-049-5000-S							2.58	0.45
E0360-049-5500-M					5.500	139.70	9.83	249.68					2.8	0.490	E0360-049-5500-S							2.33	0.41
E0360-049-6000-M					6.000	152.40	10.77	273.56					2.5	0.438	E0360-049-6000-S							2.08	0.37
E0360-055-1000-M					1.000	25.40	1.26	32.00					64.6	11.310	E0360-055-1000-S							53.81	9.42
E0360-055-1120-M					1.120	28.45	1.49	37.85					45.9	8.040	E0360-055-1120-S							38.23	6.70
E0360-055-1250-M					1.250	31.75	1.66	42.16					38.6	6.760	E0360-055-1250-S							32.15	5.63
E0360-055-1370-M					1.370	34.80	1.87	47.50					32.1	5.620	E0360-055-1370-S							26.74	4.68
E0360-055-1500-M					1.500	38.10	2.06	52.32					28.4	4.970	E0360-055-1500-S							23.66	4.14
E0360-055-1750-M					1.750	44.45	2.46	62.48					22.4	3.920	E0360-055-1750-S							18.66	3.27
E0360-055-2000-M					2.000	50.80	2.87	72.90					18.2	3.190	E0360-055-2000-S							15.16	2.66
E0360-055-2250-M					2.250	57.15	3.28	83.31					15.5	2.710	E0360-055-2250-S							12.91	2.26
E0360-055-2500-M			0.055	1.40	2.500	63.50	3.68	93.47	17.60	78.29	1.60	7.12	13.6	2.380	E0360-055-2500-S	14.66	65.22	1.33	5.93			11.33	1.98
E0360-055-2750-M					2.750	69.85	4.07	103.38					12.0	2.100	E0360-055-2750-S							10.00	1.75
E0360-055-3000-M					3.000	76.20	4.47	113.54					10.8	1.891	E0360-055-3000-S							9.00	1.58
E0360-055-3500-M					3.500	88.90	5.27	133.86					9.0	1.576	E0360-055-3500-S							7.50	1.31
E0360-055-4000-M					4.000	101.60	6.10	154.94					7.7	1.348	E0360-055-4000-S							6.41	1.12
E0360-055-4500-M	0.360	9.14			4.500	114.30	6.81	172.97					6.7	1.173	E0360-055-4500-S							5.58	0.98
E0360-055-5000-M					5.000	127.00	7.85	199.39					5.8	1.016	E0360-055-5000-S							4.83	0.85
E0360-055-5500-M					5.500	139.70	8.68	220.47					5.2	0.911	E0360-055-5500-S							4.33	0.76
E0360-055-6000-M					6.000	152.40	9.50	241.30					4.7	0.823	E0360-055-6000-S							3.92	0.69
E0360-058-1000-M					1.000	25.40	1.23	31.24					84.5	14.800	E0360-058-1000-S							70.39	12.33
E0360-058-1120-M					1.120	28.45	1.41	35.81					65.2	11.420	E0360-058-1120-S							54.31	9.51
E0360-058-1250-M					1.250	31.75	1.62	41.15					52.3	9.160	E0360-058-1250-S							43.57	7.63
E0360-058-1370-M					1.370	34.80	1.80	45.72					44.2	7.740	E0360-058-1370-S							36.82	6.45
E0360-058-1500-M					1.500	38.10	2.01	51.05					37.8	6.620	E0360-058-1500-S							31.49	5.51
E0360-058-1750-M					1.750	44.45	2.40	60.96					29.7	5.200	E0360-058-1750-S							24.74	4.33
E0360-058-2000-M					2.000	50.80	2.78	70.61					24.4	4.270	E0360-058-2000-S							20.33	3.56
E0360-058-2250-M					2.250	57.15	3.17	80.52					20.7	3.630	E0360-058-2250-S							17.24	3.02
E0360-058-2500-M			0.058	1.47	2.500	63.50	3.56	90.42	21.02	93.50	1.89	8.41	18.0	3.150	E0360-058-2500-S	17.51	77.89	1.58	7.01			14.99	2.62
E0360-058-2750-M					2.750	69.85	3.95	100.33					15.9	2.780	E0360-058-2750-S							13.24	2.32
E0360-058-3000-M					3.000	76.20	4.34	110.24					14.2	2.490	E0360-058-3000-S							11.83	2.07
E0360-058-3500-M					3.500	88.90	5.12	130.05					11.8	2.070	E0360-058-3500-S							9.83	1.72
E0360-058-4000-M					4.000	101.60	5.89	149.61					10.1	1.769	E0360-058-4000-S							8.41	1.47
E0360-058-4500-M					4.500	114.30	6.69	169.93					8.7	1.524	E0360-058-4500-S							7.25	1.27
E0360-058-5000-M					5.000	127.00	7.46	189.48					7.8	1.366	E0360-058-5000-S							6.50	1.14
E0360-058-5500-M					5.500	139.70	8.24	209.30					7.0	1.226	E0360-058-5500-S							5.83	1.02
E0360-058-6000-M					6.000	152.40	9.01	228.85					6.4	1.121	E0360-058-6000-S							5.33	0.93
T31490					0.906	23.00	1.815	46.10					5.0	0.880	T41490							4.17	0.73
T31500					1.118	28.40	2.571	65.30					3.1	0.550	T41500							2.58	0.46
T31510			0.035	0.90	1.437	36.50	3.705	94.10	5.40	24.00	0.78	3.46	2.0	0.350	T41510	4.49	19.99	0.65	2.88			1.67	0.29
T31520					1.969	50.00	5.598	142.20					1.3	0.230	T41520							1.08	0.19
T31530					2.677	68.00	8.110	206.00					0.9	0.150	T41530							0.75	0.13
T31950					1.059	26.90	1.516	38.50					35.1	6.140	T41950							29.24	5.12
T31960	0.394	10.00			1.390	35.30	2.118	53.80					21.9	3.830	T41960							18.24	3.19
T31970			0.055	1.40	1.886	47.90	3.024	76.80	18.79	83.60	2.85	12.66	14.0	2.460	T41970	15.66	69.64	2.37	10.54			11.66	2.05
T31980					2.713	68.90	4.531	115.10					8.8	1.540	T41980							7.33	1.28
T31990					11.417	290.00	20.079	510.00					1.8	0.320	T41990							1.50	0.27
T32300					1.244	31.60	1.475	37.46					181.6	31.800	T42300							151.27	26.49
T32310			0.079	2.00	1.717	43.60	2.086	52.98	49.46	220.00	7.40	32.94	113.6	19.900	T42310	41.20	183.26	6.17	27.44			94.63	16.58
T32320					2.425	61.60	3.004	76.30					73.1	12.800	T42320							60.89	10.66
E0420-037-1000-M					1.000	25.40	1.54	39.12					8.8	1.541	E0420-037-1000-S							7.33	1.28
E0420-037-1120-M					1.120	28.45	1.98	50.29					5.5	0.963	E0420-037-1120-S							4.58	0.80
E0420-037-1250-M					1.250	31.75	2.46	62.48					3.9	0.683	E0420-037-1250-S							3.25	0.57
E0420-037-1370-M	0.420	10.67	0.037	0.94	1.370	34.80	2.91	73.91	5.20	23.13	0.50	2.22	3.1	0.543	E0420-037-1370-S	4.33	19.27	0.42	1.85			2.58	0.45
E0420-037-1500-M					1.500	38.10	3.39	86.11					2.5	0.438	E0420-037-1500-S							2.08	0.37
E0420-037-1750-M					1.750	44.45	4.31	109.47					1.9	0.333	E0420-037-1750-S							1.58	0.28
E0420-037-2000-M					2.000	50.80	5.23	132.84					1.5	0.263	E0420-037-2000-S							1.25	0.22

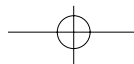

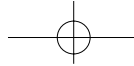

MUSIC WIRE 乐器金属弦线													STAINLESS STEEL 不锈钢金属线										
Catalog Number 编号	Outside Diameter (OD) 外径 (OD)		Wire Diameter (d) 线径 (d)		Free Length L, Approx 自由长度L (估算值)		Ext. L ₁ 拉伸长度L ₁		Load P at L ₁ L ₁ 下的承载 载荷P		Initial Tension T (Ref. only) 初始张力T (仅供参考)		Spring Rate R 弹性系数R		Catalog Number 编号	Load P at L ₁ L ₁ 下的承载 载荷P		Initial Tension T (Ref. only) 初始张力T (仅供参考)		Spring Rate R 弹性系数R			
	in	mm	in	mm	in	mm	in	mm	lb	N	lb	N	lb/in	N/mm		lb	N	lb	N	lb/in	N/mm		
E0420-037-2250-M					2.250	57.15	6.15	156.21					1.2	0.210	E0420-037-2250-S							1.00	0.18
E0420-037-2500-M			0.037	0.94	2.500	63.50	7.07	179.58	5.20	23.13	0.50	2.22	1.0	0.175	E0420-037-2500-S	4.33	19.27	0.42	1.85	0.83	0.15		
E0420-037-2750-M					2.750	69.85	7.99	202.95					0.9	0.158	E0420-037-2750-S					0.75	0.13		
E0420-037-3000-M					3.000	76.20	8.92	226.57					0.8	0.140	E0420-037-3000-S					0.67	0.12		
E0420-045-1000-M					1.000	25.40	1.38	35.05					22.0	3.850	E0420-045-1000-S					18.33	3.21		
E0420-045-1120-M					1.120	28.45	1.69	42.93					14.4	2.520	E0420-045-1120-S					12.00	2.10		
E0420-045-1250-M					1.250	31.75	2.04	51.82					10.5	1.839	E0420-045-1250-S					8.75	1.53		
E0420-045-1370-M					1.370	34.80	2.35	59.69					8.4	1.471	E0420-045-1370-S					7.00	1.23		
E0420-045-1500-M			0.045	1.14	1.500	38.10	2.69	68.33	9.06	40.30	0.82	3.65	6.9	1.208	E0420-045-1500-S					5.75	1.01		
E0420-045-1750-M					1.750	44.45	3.35	85.09					5.1	0.893	E0420-045-1750-S	7.55	33.57	0.68	3.04	4.25	0.74		
E0420-045-2000-M					2.000	50.80	4.01	101.85					4.1	0.718	E0420-045-2000-S					3.42	0.60		
E0420-045-2250-M					2.250	57.15	4.67	118.62					3.4	0.595	E0420-045-2250-S					2.83	0.50		
E0420-045-2500-M					2.500	63.50	5.33	135.38					2.9	0.508	E0420-045-2500-S					2.42	0.42		
E0420-045-2750-M	0.420	10.67			2.750	69.85	5.99	152.15					2.5	0.438	E0420-045-2750-S					2.08	0.37		
E0420-045-3000-M					3.000	76.20	6.65	168.91					2.3	0.403	E0420-045-3000-S					1.92	0.34		
E0420-055-1000-M					1.000	25.40	1.25	31.75					56.6	9.910	E0420-055-1000-S					47.15	8.26		
E0420-055-1120-M					1.120	28.45	1.49	37.85					38.8	6.790	E0420-055-1120-S					32.32	5.66		
E0420-055-1250-M					1.250	31.75	1.75	44.45					29.0	5.080	E0420-055-1250-S					24.16	4.23		
E0420-055-1370-M					1.370	34.80	1.98	50.29					23.5	4.120	E0420-055-1370-S					19.58	3.43		
E0420-055-1500-M					1.500	38.10	2.24	56.90					19.5	3.410	E0420-055-1500-S					16.24	2.84		
E0420-055-1750-M			0.055	1.40	1.750	44.45	2.73	69.34	15.80	70.28	1.40	6.23	14.7	2.570	E0420-055-1750-S	13.16	58.54	1.17	5.19	12.25	2.14		
E0420-055-2000-M					2.000	50.80	3.22	81.79					11.8	2.070	E0420-055-2000-S					9.83	1.72		
E0420-055-2250-M					2.250	57.15	3.71	94.23					9.8	1.716	E0420-055-2250-S					8.16	1.43		
E0420-055-2500-M					2.500	63.50	4.21	106.93					8.4	1.471	E0420-055-2500-S					7.00	1.23		
E0420-055-2750-M					2.750	69.85	4.70	119.38					7.4	1.296	E0420-055-2750-S					6.16	1.08		
E0420-055-3000-M					3.000	76.20	5.19	131.83					6.6	1.156	E0420-055-3000-S					5.50	0.96		
T31620					1.000	25.40	1.976	50.20					5.8	1.020	T41620					4.83	0.85		
T31630					1.236	31.40	2.795	71.00					3.7	0.640	T41630					3.08	0.53		
T31640			0.039	1.00	1.591	40.40	4.028	102.30	6.65	29.60	0.94	4.18	2.3	0.410	T41640	5.54	24.66	0.78	3.48	1.92	0.34		
T31650					2.181	55.40	6.079	154.40					1.5	0.260	T41650					1.25	0.22		
T31660					2.969	75.40	8.835	224.40					1.0	0.170	T41660					0.83	0.14		
T32080					1.185	30.10	1.646	41.80					45.9	8.040	T42080					38.23	6.70		
T32090	0.433	11.00	0.063	1.60	1.563	39.70	2.299	58.40	24.95	111.00	3.80	16.91	28.7	5.020	T42090	20.79	92.46	3.17	14.09	23.91	4.18		
T32100					2.130	54.10	3.283	83.40					18.4	3.220	T42100					15.33	2.68		
T32110					3.075	78.10	4.917	124.90					11.5	2.010	T42110					9.58	1.67		
T32420					1.370	34.80	1.618	41.10					199.9	35.000	T42420					166.52	29.16		
T32430			0.087	2.20	1.890	48.00	2.287	58.10	58.22	259.00	8.55	38.04	125.0	21.900	T42430	48.50	215.75	7.12	31.69	104.13	18.24		
T32440					2.669	67.80	3.291	83.60					79.9	14.000	T42440					66.56	11.66		
T31740					1.094	27.80	2.134	54.20					6.6	1.150	T41740					5.50	0.96		
T31750					1.354	34.40	3.020	76.70					4.1	0.720	T41750					3.42	0.60		
T31760			0.043	1.10	1.744	44.30	4.346	110.40	8.05	35.80	1.18	5.26	2.6	0.460	T41760	6.70	29.82	0.99	4.38	2.17	0.38		
T31770					2.394	60.80	6.567	166.80					1.6	0.280	T41770					1.33	0.23		
T31780					3.260	82.80	9.520	241.80					1.1	0.200	T41780					0.92	0.17		
T32200	0.472	12.00			1.307	33.20	1.776	45.10					57.7	10.100	T42200					48.06	8.41		
T32210					1.732	44.00	2.480	63.00					35.9	6.280	T42210					29.90	5.23		
T32220			0.071	1.80	2.370	60.20	3.539	89.90	31.70	141.00	4.82	21.43	23.0	4.020	T42220	26.40	117.45	4.01	17.85	19.16	3.35		
T32230					3.433	87.20	5.307	134.80					14.4	2.520	T42230					12.00	2.10		
T32240					11.417	290.00	18.307	465.00					3.9	0.680	T42240					3.25	0.57		
E0500-034-1250-M					1.250	31.75	2.56	65.02					2.4	0.420	E0500-034-1250-S					2.00	0.35		
E0500-034-1370-M					1.370	34.80	3.27	83.06					1.7	0.298	E0500-034-1370-S					1.42	0.25		
E0500-034-1500-M			0.034	0.86	1.500	38.10	4.04	102.62	3.49	15.52	0.31	1.38	1.3	0.228	E0500-034-1500-S	2.91	12.93	0.26	1.15	1.08	0.19		
E0500-034-1750-M					1.750	44.45	5.52	140.21					0.8	0.140	E0500-034-1750-S					0.67	0.12		
E0500-034-2000-M					2.000	50.80	7.00	177.80					0.6	0.105	E0500-034-2000-S					0.50	0.09		
E0500-034-2250-M					2.250	57.15	8.48	215.39					0.5	0.088	E0500-034-2250-S					0.42	0.07		
E0500-037-1250-M	0.500	12.70			1.250	31.75	2.65	67.31					2.8	0.490	E0500-037-1250-S					2.33	0.41		
E0500-037-1370-M					1.370	34.80	3.20	81.28					2.1	0.368	E0500-037-1370-S					1.75	0.31		
E0500-037-1500-M					1.500	38.10	3.81	96.77					1.7	0.298	E0500-037-1500-S					1.42	0.25		
E0500-037-1750-M			0.037	0.94	1.750	44.45	4.98	126.49	4.40	19.57	0.40	1.78	1.2	0.210	E0500-037-1750-S	3.67	16.30	0.33	1.48	1.00	0.18		
E0500-037-2000-M					2.000	50.80	6.12	155.45					1.0	0.175	E0500-037-2000-S					0.83	0.15		
E0500-037-2250-M					2.250	57.15	7.37	187.20					0.8	0.140	E0500-037-2250-S					0.67	0.12		
E0500-037-2500-M					2.500	63.50	8.54	216.92					0.7	0.123	E0500-037-2500-S					0.58	0.10		

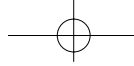

MUSIC WIRE 乐器金属弦线												STAINLESS STEEL 不锈钢金属线											
Catalog Number 编号	Outside Diameter (OD) 外径 (OD)		Wire Diameter (d) 线径 (d)		Free Length L, Approx 自由长度L (估算值)		Ext. L ₁ 拉伸长度L ₁		Load P at L ₁ L ₁ 下的承载 载荷P		Initial Tension T (Ref. only) 初始张力T (仅供参考)		Spring Rate R 弹性系数R		Catalog Number 编号	Load P at L ₁ L ₁ 下的承载 载荷P		Initial Tension T (Ref. only) 初始张力T (仅供参考)		Spring Rate R 弹性系数R			
	in	mm	in	mm	in	mm	in	mm	lb	N	lb	N	lb/in	N/mm		lb	N	lb	N	lb/in	N/mm		
E0500-037-2750-M					2.750	69.85	9.82	249.43					0.6	0.105	E0500-037-2750-S							0.50	0.09
E0500-037-3000-M					3.000	76.20	11.10	281.94					0.5	0.088	E0500-037-3000-S							0.42	0.07
E0500-037-3500-M			0.037	0.94	3.500	88.90	13.59	345.19	4.40	19.57	0.40	1.78	0.4	0.070	E0500-037-3500-S	3.67	16.30	0.33	1.48			0.33	0.06
E0500-037-4000-M					4.000	101.60	16.08	408.43					0.3	0.053	E0500-037-4000-S							0.25	0.04
E0500-037-4500-M					4.500	114.30	18.57	471.68					0.3	0.053	E0500-037-4500-S							0.25	0.04
E0500-037-5000-M					5.000	127.00	21.06	534.92					0.2	0.035	E0500-037-5000-S							0.17	0.03
E0500-041-1250-M					1.250	31.75	2.34	59.44					4.8	0.841	E0500-041-1250-S							4.00	0.70
E0500-041-1370-M					1.370	34.80	2.83	71.88					3.6	0.630	E0500-041-1370-S							3.00	0.53
E0500-041-1500-M					1.500	38.10	3.32	84.33					2.9	0.508	E0500-041-1500-S							2.42	0.42
E0500-041-1750-M					1.750	44.45	4.29	108.97					2.0	0.350	E0500-041-1750-S							1.67	0.29
E0500-041-2000-M					2.000	50.80	5.33	135.38					1.5	0.263	E0500-041-2000-S							1.25	0.22
E0500-041-2250-M					2.250	57.15	6.30	160.02					1.3	0.228	E0500-041-2250-S							1.08	0.19
E0500-041-2500-M			0.041	1.04	2.500	63.50	7.31	185.67	5.80	25.80	0.50	2.22	1.1	0.193	E0500-041-2500-S	4.83	21.49	0.42	1.85			0.92	0.16
E0500-041-2750-M					2.750	69.85	8.34	211.84					1.0	0.175	E0500-041-2750-S							0.83	0.15
E0500-041-3000-M					3.000	76.20	9.38	238.25					0.8	0.140	E0500-041-3000-S							0.67	0.12
E0500-041-3500-M					3.500	88.90	11.32	287.53					0.7	0.123	E0500-041-3500-S							0.58	0.10
E0500-041-4000-M					4.000	101.60	13.34	338.84					0.6	0.105	E0500-041-4000-S							0.50	0.09
E0500-041-4500-M					4.500	114.30	15.41	391.41					0.5	0.088	E0500-041-4500-S							0.42	0.07
E0500-041-5000-M					5.000	127.00	17.43	442.72					0.4	0.070	E0500-041-5000-S							0.33	0.06
E0500-045-1250-M					1.250	31.75	2.00	50.80					9.3	1.629	E0500-045-1250-S							7.75	1.36
E0500-045-1370-M					1.370	34.80	2.58	65.53					5.6	0.981	E0500-045-1370-S							4.66	0.82
E0500-045-1500-M					1.500	38.10	2.94	74.68					4.6	0.806	E0500-045-1500-S							3.83	0.67
E0500-045-1750-M					1.750	44.45	3.79	96.27					3.3	0.578	E0500-045-1750-S							2.75	0.48
E0500-045-2000-M					2.000	50.80	4.61	117.09					2.6	0.455	E0500-045-2000-S							2.17	0.38
E0500-045-2250-M					2.250	57.15	5.49	139.45					2.1	0.368	E0500-045-2250-S							1.75	0.31
E0500-045-2500-M			0.045	1.14	2.500	63.50	6.36	161.54	7.50	33.36	0.70	3.11	1.8	0.315	E0500-045-2500-S	6.25	27.79	0.58	2.59			1.50	0.26
E0500-045-2750-M					2.750	69.85	7.23	183.64					1.6	0.280	E0500-045-2750-S							1.33	0.23
E0500-045-3000-M					3.000	76.20	8.10	205.74					1.4	0.245	E0500-045-3000-S							1.17	0.20
E0500-045-3500-M					3.500	88.90	9.64	244.86					1.1	0.193	E0500-045-3500-S							0.92	0.16
E0500-045-4000-M	0.500	12.70			4.000	101.60	11.39	289.31					0.9	0.158	E0500-045-4000-S							0.75	0.13
E0500-045-4500-M					4.500	114.30	13.08	332.23					0.8	0.140	E0500-045-4500-S							0.67	0.12
E0500-045-5000-M					5.000	127.00	14.78	375.41					0.7	0.123	E0500-045-5000-S							0.58	0.10
E0500-049-1250-M					1.250	31.75	1.88	47.75					14.0	2.450	E0500-049-1250-S							11.66	2.04
E0500-049-1370-M					1.370	34.80	2.25	57.15					10.1	1.769	E0500-049-1370-S							8.41	1.47
E0500-049-1500-M					1.500	38.10	2.64	67.06					7.8	1.366	E0500-049-1500-S							6.50	1.14
E0500-049-1750-M					1.750	44.45	3.39	86.11					5.4	0.946	E0500-049-1750-S							4.50	0.79
E0500-049-2000-M					2.000	50.80	4.14	105.16					4.2	0.736	E0500-049-2000-S							3.50	0.61
E0500-049-2250-M					2.250	57.15	4.89	124.21					3.4	0.595	E0500-049-2250-S							2.83	0.50
E0500-049-2500-M			0.049	1.24	2.500	63.50	5.64	143.26	9.75	43.37	0.88	3.91	2.8	0.490	E0500-049-2500-S	8.12	36.13	0.73	3.26			2.33	0.41
E0500-049-2750-M					2.750	69.85	6.39	162.31					2.4	0.420	E0500-049-2750-S							2.00	0.35
E0500-049-3000-M					3.000	76.20	7.14	181.36					2.1	0.368	E0500-049-3000-S							1.75	0.31
E0500-049-3500-M					3.500	88.90	8.64	219.46					1.7	0.298	E0500-049-3500-S							1.42	0.25
E0500-049-4000-M					4.000	101.60	10.15	257.81					1.4	0.245	E0500-049-4000-S							1.17	0.20
E0500-049-4500-M					4.500	114.30	11.67	296.42					1.2	0.210	E0500-049-4500-S							1.00	0.18
E0500-049-5000-M					5.000	127.00	13.15	334.01					1.1	0.193	E0500-049-5000-S							0.92	0.16
E0500-055-1250-M					1.250	31.75	1.75	44.45					24.4	4.270	E0500-055-1250-S							20.33	3.56
E0500-055-1370-M					1.370	34.80	2.14	54.36					15.6	2.730	E0500-055-1370-S							12.99	2.27
E0500-055-1500-M					1.500	38.10	2.41	61.21					13.0	2.280	E0500-055-1500-S							10.83	1.90
E0500-055-1750-M					1.750	44.45	3.01	76.45					9.0	1.576	E0500-055-1750-S							7.50	1.31
E0500-055-2000-M					2.000	50.80	3.60	91.44					7.4	1.296	E0500-055-2000-S							6.16	1.08
E0500-055-2250-M					2.250	57.15	4.29	108.97					6.1	1.068	E0500-055-2250-S							5.08	0.89
E0500-055-2500-M			0.055	1.40	2.500	63.50	4.82	122.43	13.10	58.27	1.20	5.34	5.1	0.893	E0500-055-2500-S	10.91	48.54	1.00	4.45			4.25	0.74
E0500-055-2750-M					2.750	69.85	5.41	137.41					4.4	0.771	E0500-055-2750-S							3.67	0.64
E0500-055-3000-M					3.000	76.20	6.01	152.65					3.9	0.683	E0500-055-3000-S							3.25	0.57
E0500-055-3500-M					3.500	88.90	7.19	182.63					3.2	0.560	E0500-055-3500-S							2.67	0.47
E0500-055-4000-M					4.000	101.60	8.38	212.85					2.7	0.473	E0500-055-4000-S							2.25	0.39
E0500-055-4500-M					4.500	114.30	9.56	242.82					2.3	0.403	E0500-055-4500-S							1.92	0.34
E0500-055-5000-M					5.000	127.00	11.10	281.94					2.0	0.350	E0500-055-5000-S							1.67	0.29
E0500-063-1250-M					1.250	31.75	1.63	41.40					46.9	8.210	E0500-063-1250-S							39.07	6.84
E0500-063-1370-M			0.063	1.60	1.370	34.80	1.92	48.77	18.80	83.63	1.70	7.56	31.2	5.460	E0500-063-1370-S	15.66	69.66	1.42	6.30			25.99	4.55
E0500-063-1500-M					1.500	38.10	2.17	55.12					25.5	4.470	E0500-063-1500-S							21.24	3.72

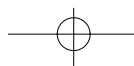

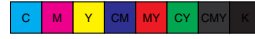
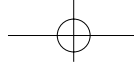

MUSIC WIRE 乐器金属弦线											STAINLESS STEEL 不锈钢金属线												
Catalog Number 编号	Outside Diameter (OD) 外径 (OD)		Wire Diameter (d) 线径 (d)		Free Length L, Approx 自由长度L (估算值)		Ext. L _i 拉伸长度L _i		Load P at L _i L _i 下的承载 载荷P		Initial Tension T (Ref. only) 初始张力T (仅供参考)		Spring Rate R 弹性系数R		Catalog Number 编号	Load P at L _i L _i 下的承载 载荷P		Initial Tension T (Ref. only) 初始张力T (仅供参考)		Spring Rate R 弹性系数R			
	in	mm	in	mm	in	mm	in	mm	lb	N	lb	N	lb/in	N/mm		lb	N	lb	N	lb/in	N/mm		
E0500-063-1750-M					1.750	44.45	2.66	67.56					18.7	3.270	E0500-063-1750-S							15.58	2.72
E0500-063-2000-M					2.000	50.80	3.16	80.26					14.8	2.590	E0500-063-2000-S							12.33	2.16
E0500-063-2250-M					2.250	57.15	3.65	92.71					12.2	2.140	E0500-063-2250-S							10.16	1.78
E0500-063-2500-M					2.500	63.50	4.12	104.65					10.4	1.821	E0500-063-2500-S							8.66	1.52
E0500-063-2750-M			0.063	1.60	2.750	69.85	4.60	116.84	18.80	83.63	1.70	7.56	9.2	1.611	E0500-063-2750-S	15.66	69.66	1.42	6.30		7.66	1.34	
E0500-063-3000-M					3.000	76.20	5.10	129.54					8.1	1.419	E0500-063-3000-S							6.75	1.18
E0500-063-3500-M					3.500	88.90	6.08	154.43					6.6	1.156	E0500-063-3500-S							5.50	0.96
E0500-063-4000-M					4.000	101.60	7.07	179.58					5.5	0.963	E0500-063-4000-S							4.58	0.80
E0500-063-4500-M					4.500	114.30	8.06	204.72					4.8	0.841	E0500-063-4500-S							4.00	0.70
E0500-063-5000-M					5.000	127.00	9.04	229.62					4.2	0.736	E0500-063-5000-S							3.50	0.61
E0500-069-1250-M					1.250	31.75	1.55	39.37					74.0	12.960	E0500-069-1250-S							61.64	10.80
E0500-069-1370-M					1.370	34.80	1.78	45.21					54.3	9.510	E0500-069-1370-S							45.23	7.92
E0500-069-1500-M					1.500	38.10	1.99	50.55					45.2	7.920	E0500-069-1500-S							37.65	6.60
E0500-069-1750-M					1.750	44.45	2.45	62.23					31.3	5.480	E0500-069-1750-S							26.07	4.57
E0500-069-2000-M					2.000	50.80	2.89	73.41					24.7	4.330	E0500-069-2000-S							20.58	3.61
E0500-069-2250-M					2.250	57.15	3.33	84.58					20.3	3.560	E0500-069-2250-S							16.91	2.97
E0500-069-2500-M			0.069	1.75	2.500	63.50	3.77	95.76	24.21	107.69	2.18	9.70	17.3	3.030	E0500-069-2500-S	20.17	89.71	1.82	8.08		14.41	2.52	
E0500-069-2750-M	0.500	12.70			2.750	69.85	4.24	107.70					14.8	2.590	E0500-069-2750-S							12.33	2.16
E0500-069-3000-M					3.000	76.20	4.68	118.87					13.1	2.290	E0500-069-3000-S							10.91	1.91
E0500-069-3500-M					3.500	88.90	5.56	141.22					10.7	1.874	E0500-069-3500-S							8.91	1.56
E0500-069-4000-M					4.000	101.60	6.46	164.08					8.9	1.559	E0500-069-4000-S							7.41	1.30
E0500-069-4500-M					4.500	114.30	7.34	186.44					7.8	1.366	E0500-069-4500-S							6.50	1.14
E0500-069-5000-M					5.000	127.00	8.25	209.55					6.8	1.191	E0500-069-5000-S							5.66	0.99
E0500-075-1250-M					1.250	31.75	1.51	38.35					107.7	18.860	E0500-075-1250-S							89.71	15.71
E0500-075-1370-M					1.370	34.80	1.70	43.18					84.6	14.810	E0500-075-1370-S							70.47	12.34
E0500-075-1500-M					1.500	38.10	1.90	48.26					69.7	12.200	E0500-075-1500-S							58.06	10.16
E0500-075-1750-M					1.750	44.45	2.31	58.67					49.4	8.650	E0500-075-1750-S							41.15	7.21
E0500-075-2000-M					2.000	50.80	2.73	69.34					38.2	6.690	E0500-075-2000-S							31.82	5.57
E0500-075-2250-M					2.250	57.15	3.12	79.25					32.0	5.600	E0500-075-2250-S							26.66	4.67
E0500-075-2500-M			0.075	1.91	2.500	63.50	3.53	89.66	30.51	135.71	2.75	12.23	26.9	4.710	E0500-075-2500-S	25.42	113.05	2.29	10.19		22.41	3.92	
E0500-075-2750-M					2.750	69.85	3.95	100.33					23.2	4.060	E0500-075-2750-S							19.33	3.38
E0500-075-3000-M					3.000	76.20	4.34	110.24					20.8	3.640	E0500-075-3000-S							17.33	3.03
E0500-075-3500-M					3.500	88.90	5.16	131.06					16.7	2.920	E0500-075-3500-S							13.91	2.43
E0500-075-4000-M					4.000	101.60	5.97	151.64					14.1	2.470	E0500-075-4000-S							11.75	2.06
E0500-075-4500-M					4.500	114.30	6.77	171.96					12.2	2.140	E0500-075-4500-S							10.16	1.78
E0500-075-5000-M					5.000	127.00	7.60	193.04					10.7	1.874	E0500-075-5000-S							8.91	1.56
T31870					1.189	30.20	2.287	58.10					7.3	1.280	T41870							6.08	1.07
T31880					1.472	37.40	3.232	82.10					4.6	0.800	T41880							3.83	0.67
T31890			0.047	1.20	1.898	48.20	4.646	118.00	9.49	42.20	1.47	6.56	2.9	0.510	T41890	7.90	35.15	1.23	5.47		2.42	0.43	
T31900	0.512	13.00			2.606	66.20	7.016	178.20					1.8	0.320	T41900							1.50	0.27
T31910					3.551	90.20	10.165	258.20					1.2	0.210	T41910							1.00	0.18
T32540					1.587	40.30	1.895	48.14					195.9	34.300	T42540							163.18	28.57
T32550			0.098	2.50	2.177	55.30	2.669	67.80	71.26	317.00	10.85	48.27	122.8	21.500	T42550	59.36	264.06	9.04	40.21		102.29	17.91	
T32560					3.063	77.80	3.835	97.40					78.2	13.700	T42560							65.14	11.41
T32330					1.496	38.00	2.075	52.70					53.8	9.420	T42330							44.82	7.85
T32340			0.079	2.00	1.969	50.00	2.898	73.60	36.87	164.00	5.68	25.25	33.6	5.880	T42340	30.71	136.61	4.73	21.03		27.99	4.90	
T32350					2.677	68.00	4.130	104.90					21.5	3.770	T42350							17.91	3.14
T32360	0.551	14.00			3.858	98.00	6.181	157.00					13.4	2.350	T42360							11.16	1.96
T32660					1.740	44.20	2.041	51.85					254.7	44.600	T42660							212.17	37.15
T32670			0.110	2.80	2.402	61.00	2.882	73.20	89.92	400.00	13.23	58.85	159.3	27.900	T42670	74.90	333.20	11.02	49.02		132.70	23.24	
T32680					3.394	86.20	4.146	105.30					102.2	17.900	T42680							85.13	14.91
T32000					1.374	34.90	2.602	66.10					8.9	1.550	T42000							7.41	1.29
T32010					1.705	43.30	3.673	93.30					5.5	0.970	T42010							4.58	0.81
T32020			0.055	1.40	2.201	55.90	5.276	134.00	12.84	57.10	1.93	8.57	3.5	0.620	T42020	10.69	47.56	1.61	7.14		2.92	0.52	
T32030					3.028	76.90	7.949	201.90					2.2	0.390	T42030							1.83	0.33
T32040	0.591	15.00			4.134	105.00	11.496	292.00					1.5	0.260	T42040							1.25	0.22
T32450					1.622	41.20	2.205	56.00					65.1	11.400	T42450							54.23	9.50
T32460			0.087	2.20	2.142	54.40	3.075	78.10	44.51	198.00	6.66	29.63	40.5	7.100	T42460	37.08	164.93	5.55	24.68		33.74	5.91	
T32470					2.921	74.20	4.378	111.20					26.0	4.550	T42470							21.66	3.79
T32480					4.213	107.00	6.543	166.20					16.22	2.840	T42480							13.51	2.37
T32780	0.630	16.00	0.126	3.20	1.992	50.60	2.328	59.12	114.65	510.00	17.18	76.44	290.6	50.900	T42780	95.50	424.83	14.32	63.68		242.07	42.40	

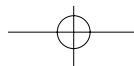

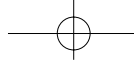

MUSIC WIRE 乐器金属弦线														STAINLESS STEEL 不锈钢金属线									
Catalog Number 编号	Outside Diameter (OD) 外径 (OD)		Wire Diameter (d) 线径 (d)		Free Length L, Approx 自由长度L (估算值)		Ext. L ₁ 拉伸长度L ₁		Load P at L ₁ L ₁ 下的承载 载荷P		Initial Tension T (Ref. only) 初始张力T (仅供参考)		Spring Rate R 弹性系数R		Catalog Number 编号	Load P at L ₁ L ₁ 下的承载 载荷P		Initial Tension T (Ref. only) 初始张力T (仅供参考)		Spring Rate R 弹性系数R			
	in	mm	in	mm	in	mm	in	mm	lb	N	lb	N	lb/in	N/mm		lb	N	lb	N	lb/in	N/mm		
T32790	0.630	16.00	0.126	3.20	2.748	69.80	3.283	83.40	114.65	510.00	17.18	76.44	181.6	31.800	T42790	95.50	424.83	14.32	63.68	151.27	26.49		
T32800					3.882	98.60	4.720	119.90					116.5	20.400	T42800					97.04	16.99		
E0650-055-1500-M					1.500	38.10	2.21	56.13					13.4	2.350	E0650-055-1500-S					11.16	1.96		
E0650-055-1750-M					1.750	44.45	3.16	80.26					6.8	1.191	E0650-055-1750-S					5.66	0.99		
E0650-055-2000-M					2.000	50.80	4.20	106.68					4.1	0.718	E0650-055-2000-S					3.42	0.60		
E0650-055-2250-M					2.250	57.15	5.13	130.30					3.2	0.560	E0650-055-2250-S					2.67	0.47		
E0650-055-2500-M			0.055	1.40	2.500	63.50	5.98	151.89	10.10	44.93	0.90	4.00	2.6	0.455	E0650-055-2500-S	8.41	37.43	0.75	3.33	2.17	0.38		
E0650-055-2750-M					2.750	69.85	6.94	176.28					2.2	0.385	E0650-055-2750-S					1.83	0.32		
E0650-055-3000-M					3.000	76.20	7.83	198.88					1.9	0.333	E0650-055-3000-S					1.58	0.28		
E0650-055-3500-M					3.500	88.90	9.61	244.09					1.5	0.263	E0650-055-3500-S					1.25	0.22		
E0650-055-4000-M					4.000	101.60	11.38	289.05					1.2	0.210	E0650-055-4000-S					1.00	0.18		
E0650-063-1500-M					1.500	38.10	2.06	52.32					24.8	4.340	E0650-063-1500-S					20.66	3.62		
E0650-063-1750-M					1.750	44.45	2.81	71.37					13.2	2.310	E0650-063-1750-S					11.00	1.92		
E0650-063-2000-M					2.000	50.80	3.61	91.69					8.3	1.454	E0650-063-2000-S					6.91	1.21		
E0650-063-2250-M					2.250	57.15	4.32	109.73					6.4	1.121	E0650-063-2250-S					5.33	0.93		
E0650-063-2500-M					2.500	63.50	5.03	127.76					5.3	0.928	E0650-063-2500-S					4.41	0.77		
E0650-063-2750-M	0.650	16.51	0.063	1.60	2.750	69.85	5.74	145.80	14.80	65.83	1.40	6.23	4.4	0.771	E0650-063-2750-S	12.33	54.84	1.17	5.19	3.67	0.64		
E0650-063-3000-M					3.000	76.20	6.45	163.83					3.8	0.665	E0650-063-3000-S					3.17	0.55		
E0650-063-3500-M					3.500	88.90	7.87	199.90					3.0	0.525	E0650-063-3500-S					2.50	0.44		
E0650-063-4000-M					4.000	101.60	9.29	235.97					2.5	0.438	E0650-063-4000-S					2.08	0.37		
E0650-063-4500-M					4.500	114.30	10.71	272.03					2.1	0.368	E0650-063-4500-S					1.75	0.31		
E0650-063-5000-M					5.000	127.00	12.49	317.25					1.9	0.333	E0650-063-5000-S					1.58	0.28		
E0650-069-1750-M					1.750	44.45	2.62	66.55					20.7	3.630	E0650-069-1750-S					17.24	3.02		
E0650-069-2000-M					2.000	50.80	3.26	82.80					14.2	2.490	E0650-069-2000-S					11.83	2.07		
E0650-069-2250-M					2.250	57.15	3.90	99.06					10.9	1.909	E0650-069-2250-S					9.08	1.59		
E0650-069-2500-M					2.500	63.50	4.55	115.57					8.8	1.541	E0650-069-2500-S					7.33	1.28		
E0650-069-2750-M			0.069	1.75	2.750	69.85	5.19	131.83	19.80	88.07	1.90	8.45	7.4	1.296	E0650-069-2750-S	16.49	73.36	1.58	7.04	6.16	1.08		
E0650-069-3000-M					3.000	76.20	5.83	148.08					6.4	1.121	E0650-069-3000-S					5.33	0.93		
E0650-069-3500-M					3.500	88.90	7.12	180.85					5.0	0.876	E0650-069-3500-S					4.17	0.73		
E0650-069-4000-M					4.000	101.60	8.40	213.36					4.1	0.718	E0650-069-4000-S					3.42	0.60		
E0650-069-4500-M					4.500	114.30	9.68	245.87					3.5	0.613	E0650-069-4500-S					2.92	0.51		
E0650-069-5000-M					5.000	127.00	10.97	278.64					3.0	0.525	E0650-069-5000-S					2.50	0.44		
T32120					1.563	39.70	2.913	74.00					10.4	1.820	T42120					8.66	1.52		
T32130					1.941	49.30	4.098	104.10					6.5	1.140	T42130					5.41	0.95		
T32140	0.669	17.00	0.063	1.60	2.508	63.70	5.878	149.30	16.64	74.00	2.61	11.62	4.2	0.730	T42140	13.86	61.64	2.18	9.68	3.50	0.61		
T32150					3.453	87.70	8.846	224.70					2.6	0.460	T42150					2.17	0.38		
T32160					4.724	120.00	12.795	325.00					1.7	0.300	T42160					1.42	0.25		
T32570					1.902	48.30	2.646	67.20					61.1	10.700	T42570					50.90	8.91		
T32580			0.098	2.50	2.492	63.30	3.685	93.60	53.28	237.00	7.85	34.90	38.1	6.670	T42580	44.38	197.42	6.54	29.07	31.74	5.56		
T32590					3.378	85.80	5.240	133.10					24.4	4.270	T42590					20.33	3.56		
T32600	0.709	18.00			4.843	123.00	7.823	198.70					15.2	2.670	T42600					12.66	2.22		
T32900					2.240	56.90	2.608	66.25					326.6	57.200	T42900					272.06	47.65		
T32910			0.142	3.60	3.091	78.50	3.681	93.50	141.62	630.00	21.16	94.11	204.4	35.800	T42910	117.97	524.79	17.62	78.39	170.27	29.82		
T32920					4.370	111.00	5.291	134.40					130.8	22.900	T42920					108.96	19.08		
E0750-049-2000-M					2.000	50.80	4.64	117.86					2.3	0.403	E0750-049-2000-S					1.92	0.34		
E0750-049-2250-M					2.250	57.15	6.16	156.46					1.5	0.263	E0750-049-2250-S					1.25	0.22		
E0750-049-2500-M					2.500	63.50	7.69	195.33					1.2	0.210	E0750-049-2500-S					1.00	0.18		
E0750-049-2750-M			0.049	1.24	2.750	69.85	9.21	233.93	6.61	29.40	0.59	2.62	0.9	0.158	E0750-049-2750-S	5.51	24.49	0.49	2.18	0.75	0.13		
E0750-049-3000-M					3.000	76.20	10.74	272.80					0.8	0.140	E0750-049-3000-S					0.67	0.12		
E0750-049-3250-M					3.250	82.55	12.26	311.40					0.7	0.123	E0750-049-3250-S					0.58	0.10		
E0750-049-3500-M					3.500	88.90	13.79	350.27					0.6	0.105	E0750-049-3500-S					0.50	0.09		
E0750-055-2000-M	0.750	19.05			2.000	50.80	4.36	110.74					3.3	0.578	E0750-055-2000-S					2.75	0.48		
E0750-055-2250-M					2.250	57.15	5.50	139.70					2.4	0.420	E0750-055-2250-S					2.00	0.35		
E0750-055-2500-M			0.055	1.40	2.500	63.50	6.64	168.66	8.80	39.14	0.80	3.56	1.9	0.333	E0750-055-2500-S	7.33	32.60	0.67	2.97	1.58	0.28		
E0750-055-2750-M					2.750	69.85	7.77	197.36					1.5	0.263	E0750-055-2750-S					1.25	0.22		
E0750-055-3000-M					3.000	76.20	8.91	226.31					1.3	0.228	E0750-055-3000-S					1.08	0.19		
E0750-055-3500-M					3.500	88.90	11.28	286.51					1.0	0.175	E0750-055-3500-S					0.83	0.15		
E0750-063-2000-M					2.000	50.80	3.77	95.76					6.5	1.138	E0750-063-2000-S					5.41	0.95		
E0750-063-2250-M			0.063	1.60	2.250	57.15	4.67	118.62	12.80	56.94	1.20	5.34	4.8	0.841	E0750-063-2250-S	10.66	47.43	1.00	4.45	4.00	0.70		
E0750-063-2500-M																							

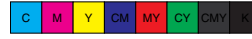
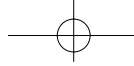

MUSIC WIRE 乐器金属弦线											STAINLESS STEEL 不锈钢金属线												
Catalog Number 编号	Outside Diameter (OD) 外径 (OD)		Wire Diameter (d) 线径 (d)		Free Length L, Approx 自由长度L (估算值)		Ext. L ₁ 拉伸长度L ₁		Load P at L ₁ L ₁ 下的承载 载荷P		Initial Tension T (Ref. only) 初始张力T (仅供参考)		Spring Rate R 弹性系数R		Catalog Number 编号	Load P at L ₁ L ₁ 下的承载 载荷P		Initial Tension T (Ref. only) 初始张力T (仅供参考)		Spring Rate R 弹性系数R			
	in	mm	in	mm	in	mm	in	mm	lb	N	lb	N	lb/in	N/mm		lb	N	lb	N	lb/in	N/mm		
E0750-063-3000-M					3.000	76.20	7.35	186.69					2.6	0.455	E0750-063-3000-S							2.17	0.38
E0750-063-3500-M					3.500	88.90	9.05	229.87					2.0	0.350	E0750-063-3500-S							1.67	0.29
E0750-063-4000-M			0.063	1.60	4.000	101.60	10.84	275.34	12.80	56.94	1.20	5.34	1.7	0.298	E0750-063-4000-S	10.66	47.43	1.00	4.45		1.42	0.25	
E0750-063-4500-M					4.500	114.30	12.63	320.80					1.4	0.245	E0750-063-4500-S						1.17	0.20	
E0750-063-5000-M					5.000	127.00	14.42	366.27					1.2	0.210	E0750-063-5000-S						1.00	0.18	
E0750-063-5500-M					5.500	139.70	16.75	425.45					1.1	0.193	E0750-063-5500-S						0.92	0.16	
E0750-069-2000-M					2.000	50.80	3.29	83.57					12.2	2.140	E0750-069-2000-S						10.16	1.78	
E0750-069-2250-M					2.250	57.15	4.10	104.14					8.5	1.490	E0750-069-2250-S						7.08	1.24	
E0750-069-2500-M					2.500	63.50	4.89	124.21					6.6	1.156	E0750-069-2500-S						5.50	0.96	
E0750-069-2750-M					2.750	69.85	5.69	144.53					5.3	0.928	E0750-069-2750-S						4.41	0.77	
E0750-069-3000-M			0.069	1.75	3.000	76.20	6.50	165.10	17.26	76.78	1.55	6.89	4.5	0.788	E0750-069-3000-S	14.38	63.96	1.29	5.74		3.75	0.66	
E0750-069-3500-M					3.500	88.90	8.10	205.74					3.4	0.595	E0750-069-3500-S						2.83	0.50	
E0750-069-4000-M					4.000	101.60	9.70	246.38					2.8	0.490	E0750-069-4000-S						2.33	0.41	
E0750-069-4500-M					4.500	114.30	11.31	287.27					2.3	0.403	E0750-069-4500-S						1.92	0.34	
E0750-069-5000-M					5.000	127.00	12.91	327.91					2.0	0.350	E0750-069-5000-S						1.67	0.29	
E0750-075-2000-M					2.000	50.80	3.16	80.26					16.2	2.840	E0750-075-2000-S						13.49	2.37	
E0750-075-2250-M					2.250	57.15	3.83	97.28					11.8	2.070	E0750-075-2250-S						9.83	1.72	
E0750-075-2500-M					2.500	63.50	4.51	114.55					9.3	1.629	E0750-075-2500-S						7.75	1.36	
E0750-075-2750-M					2.750	69.85	5.13	130.30					7.9	1.384	E0750-075-2750-S						6.58	1.15	
E0750-075-3000-M					3.000	76.20	5.80	147.32					6.7	1.173	E0750-075-3000-S						5.58	0.98	
E0750-075-3500-M			0.075	1.91	3.500	88.90	7.09	180.09	20.70	92.08	1.90	8.45	5.2	0.911	E0750-075-3500-S	17.24	76.70	1.58	7.04		4.33	0.76	
E0750-075-4000-M					4.000	101.60	8.45	214.63					4.2	0.736	E0750-075-4000-S						3.50	0.61	
E0750-075-4500-M					4.500	114.30	9.74	247.40					3.5	0.613	E0750-075-4500-S						2.92	0.51	
E0750-075-5000-M					5.000	127.00	11.03	280.16					3.1	0.543	E0750-075-5000-S						2.58	0.45	
E0750-075-5500-M					5.500	139.70	12.83	325.88					2.7	0.473	E0750-075-5500-S						2.25	0.39	
E0750-075-6000-M					6.000	152.40	14.23	361.44					2.4	0.420	E0750-075-6000-S						2.00	0.35	
E0750-085-2000-M					2.000	50.80	2.83	71.88					33.9	5.940	E0750-085-2000-S						28.24	4.95	
E0750-085-2250-M					2.250	57.15	3.40	86.36					24.4	4.270	E0750-085-2250-S						20.33	3.56	
E0750-085-2500-M	0.750	19.05			2.500	63.50	3.97	100.84					19.0	3.330	E0750-085-2500-S						15.83	2.77	
E0750-085-2750-M					2.750	69.85	4.55	115.57					15.6	2.730	E0750-085-2750-S						12.99	2.27	
E0750-085-3000-M			0.085	2.16	3.000	76.20	5.12	130.05	30.82	137.09	2.77	12.32	13.2	2.310	E0750-085-3000-S	25.67	114.20	2.31	10.26		11.00	1.92	
E0750-085-3500-M					3.500	88.90	6.27	159.26					10.1	1.769	E0750-085-3500-S						8.41	1.47	
E0750-085-4000-M					4.000	101.60	7.41	188.21					8.2	1.436	E0750-085-4000-S						6.83	1.20	
E0750-085-4500-M					4.500	114.30	8.56	217.42					6.9	1.208	E0750-085-4500-S						5.75	1.01	
E0750-085-5000-M					5.000	127.00	9.71	246.63					6.0	1.051	E0750-085-5000-S						5.00	0.88	
E0750-095-2000-M					2.000	50.80	2.63	66.80					59.5	10.420	E0750-095-2000-S						49.56	8.68	
E0750-095-2250-M					2.250	57.15	3.10	78.74					43.9	7.690	E0750-095-2250-S						36.57	6.41	
E0750-095-2500-M					2.500	63.50	3.62	91.95					33.3	5.830	E0750-095-2500-S						27.74	4.86	
E0750-095-2750-M					2.750	69.85	4.10	104.14					27.8	4.870	E0750-095-2750-S						23.16	4.06	
E0750-095-3000-M					3.000	76.20	4.57	116.08					23.8	4.170	E0750-095-3000-S						19.83	3.47	
E0750-095-3500-M			0.095	2.41	3.500	88.90	5.57	141.48	41.21	183.30	3.71	16.50	18.1	3.170	E0750-095-3500-S	34.33	152.69	3.09	13.74		15.08	2.64	
E0750-095-4000-M					4.000	101.60	6.52	165.61					14.9	2.610	E0750-095-4000-S						12.41	2.17	
E0750-095-4500-M					4.500	114.30	7.51	190.75					12.4	2.170	E0750-095-4500-S						10.33	1.81	
E0750-095-5000-M					5.000	127.00	8.46	214.88					10.8	1.891	E0750-095-5000-S						9.00	1.58	
E0750-095-5500-M					5.500	139.70	9.46	240.28					9.5	1.664	E0750-095-5500-S						7.91	1.39	
E0750-095-6000-M					6.000	152.40	10.41	264.41					8.5	1.489	E0750-095-6000-S						7.08	1.24	
E0750-105-2000-M					2.000	50.80	2.50	63.50					100.2	17.550	E0750-105-2000-S						83.47	14.62	
E0750-105-2250-M					2.250	57.15	2.94	74.68					72.4	12.680	E0750-105-2250-S						60.31	10.56	
E0750-105-2500-M					2.500	63.50	3.38	85.85					56.6	9.910	E0750-105-2500-S						47.15	8.26	
E0750-105-2750-M					2.750	69.85	3.83	97.28					46.5	8.140	E0750-105-2750-S						38.73	6.78	
E0750-105-3000-M			0.105	2.67	3.000	76.20	4.27	108.46	54.96	244.46	4.95	22.02	39.5	6.920	E0750-105-3000-S	45.78	203.64	4.12	18.34		32.90	5.76	
E0750-105-3500-M					3.500	88.90	5.11	129.90					31.0	5.430	E0750-105-3500-S						25.82	4.52	
E0750-105-4000-M					4.000	101.60	6.00	152.40					25.0	4.380	E0750-105-4000-S						20.83	3.65	
E0750-105-4500-M					4.500	114.30	6.84	173.74					21.3	3.730	E0750-105-4500-S						17.74	3.11	
E0750-105-5000-M					5.000	127.00	7.73	196.34					18.3	3.200	E0750-105-5000-S						15.24	2.67	
E0750-115-2000-M					2.000	50.80	2.42	61.47					151.1	26.460	E0750-115-2000-S						125.87	22.04	
E0750-115-2250-M					2.250	57.15	2.80	71.12					115.5	20.220	E0750-115-2250-S						96.21	16.84	
E0750-115-2500-M			0.115	2.92	2.500	63.50	3.21	81.53	69.69	309.98	6.27	27.89	89.3	15.640	E0750-115-2500-S	58.05	258.21	5.22	23.23		74.39	13.03	
E0750-115-2750-M					2.750	69.85	3.59	91.19					75.5	13.220	E0750-115-2750-S						62.89	11.01	
E0750-115-3000-M					3.000	76.20	3.97	100.84					65.5	11.470	E0750-115-3000-S						54.56	9.56	
E0750-115-3500-M					3.500	88.90	4.76	120.90					50.4	8.830	E0750-115-3500-S						41.98	7.36	

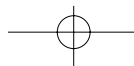

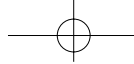

MUSIC WIRE 乐器金属弦线											STAINLESS STEEL 不锈钢金属线												
Catalog Number 编号	Outside Diameter (OD) 外径 (OD)		Wire Diameter (d) 线径 (d)		Free Length L ₁ , Approx 自由长度L ₁ (估算值)		Ext. L ₁ 拉伸长度L ₁		Load P at L ₁ L ₁ 下的承载 载荷P		Initial Tension T (Ref. only) 初始张力T (仅供参考)		Spring Rate R 弹性系数R		Catalog Number 编号	Load P at L ₁ L ₁ 下的承载 载荷P		Initial Tension T (Ref. only) 初始张力T (仅供参考)		Spring Rate R 弹性系数R			
	in	mm	in	mm	in	mm	in	mm	lb	N	lb	N	lb/in	N/mm		lb	N	lb	N	lb/in	N/mm		
E0750-115-4000-M					4.000	101.60	5.55	140.97					40.9	7.160	E0750-115-4000-S							34.07	5.96
E0750-115-4500-M					4.500	114.30	6.31	160.27					35.1	6.150	E0750-115-4500-S							29.24	5.12
E0750-115-5000-M			0.115	2.92	5.000	127.00	7.10	180.34	69.69	309.98	6.27	27.89	30.2	5.290	E0750-115-5000-S	58.05	258.21	5.22	23.23		25.16	4.41	
E0750-115-5500-M					5.500	139.70	7.89	200.41					26.5	4.640	E0750-115-5500-S							22.07	3.87
E0750-115-6000-M					6.000	152.40	8.65	219.71					23.9	4.190	E0750-115-6000-S							19.91	3.49
E0750-125-2000-M					2.000	50.80	2.33	59.18					239.6	41.950	E0750-125-2000-S							199.59	34.94
E0750-125-2250-M	0.750	19.05			2.250	57.15	2.70	68.58					179.7	31.470	E0750-125-2250-S							149.69	26.22
E0750-125-2500-M					2.500	63.50	3.06	77.72					143.8	25.180	E0750-125-2500-S							119.79	20.98
E0750-125-2750-M					2.750	69.85	3.42	86.87					119.8	20.980	E0750-125-2750-S							99.79	17.48
E0750-125-3000-M			0.125	3.18	3.000	76.20	3.78	96.01	87.94	391.16	7.91	35.18	102.7	17.980	E0750-125-3000-S	73.25	325.84	6.59	29.30		85.55	14.98	
E0750-125-3500-M					3.500	88.90	4.50	114.30					79.9	13.990	E0750-125-3500-S							66.56	11.65
E0750-125-4000-M					4.000	101.60	5.22	132.59					65.3	11.430	E0750-125-4000-S							54.39	9.52
E0750-125-4500-M					4.500	114.30	5.95	151.13					55.3	9.680	E0750-125-4500-S							46.06	8.06
E0750-125-5000-M					5.000	127.00	6.67	169.42					47.9	8.390	E0750-125-5000-S							39.90	6.99
T32250					1.811	46.00	3.461	87.90					10.2	1.780	T42250							8.50	1.48
T32260					2.236	56.80	4.874	123.80					6.3	1.110	T42260							5.25	0.93
T32270			0.071	1.80	2.874	73.00	7.008	178.00	19.56	87.00	2.93	13.05	4.1	0.710	T42270	16.29	72.47	2.44	10.87		3.42	0.59	
T32280					3.937	100.00	10.512	267.00					2.5	0.440	T42280							2.08	0.37
T32290					5.354	136.00	15.236	387.00					1.7	0.290	T42290							1.42	0.24
T32690	0.787	20.00			2.118	53.80	2.917	74.10					70.2	12.300	T42690							58.48	10.25
T32700			0.110	2.80	2.780	70.60	4.055	103.00	65.87	293.00	9.91	44.09	43.9	7.680	T42700	54.87	244.07	8.26	36.73		36.57	6.40	
T32710					3.772	95.80	5.764	146.40					28.0	4.910	T42710							23.32	4.09
T32720					5.433	138.00	8.622	219.00					17.5	3.070	T42720							14.58	2.56
T33020					2.488	63.20	2.886	73.30					363.2	63.600	T43020							302.55	52.98
T33030			0.157	4.00	3.433	87.20	4.071	103.40	170.17	757.00	25.69	114.29	226.7	39.700	T43030	141.76	630.58	21.40	95.21		188.84	33.07	
T33040					4.843	123.00	5.839	148.30					145.0	25.400	T43040							120.79	21.16
E0850-055-2000-M					2.000	50.80	4.22	107.19					3.2	0.560	E0850-055-2000-S							2.67	0.47
E0850-055-2250-M			0.055	1.40	2.250	57.15	5.65	143.51	7.80	34.70	0.70	3.11	2.1	0.368	E0850-055-2250-S	6.50	28.91	0.58	2.59		1.75	0.31	
E0850-055-2500-M					2.500	63.50	7.07	179.58					1.6	0.280	E0850-055-2500-S							1.33	0.23
E0850-055-2750-M					2.750	69.85	8.50	215.90					1.2	0.210	E0850-055-2750-S							1.00	0.18
E0850-063-2250-M					2.250	57.15	4.88	123.95					3.9	0.683	E0850-063-2250-S							3.25	0.57
E0850-063-2500-M					2.500	63.50	6.04	153.42					2.9	0.508	E0850-063-2500-S							2.42	0.42
E0850-063-2750-M			0.063	1.60	2.750	69.85	7.21	183.13	11.30	50.26	1.00	4.45	2.3	0.403	E0850-063-2750-S	9.41	41.87	0.83	3.71		1.92	0.34	
E0850-063-3000-M					3.000	76.20	8.37	212.60					1.9	0.333	E0850-063-3000-S							1.58	0.28
E0850-063-3500-M					3.500	88.90	10.70	271.78					1.4	0.245	E0850-063-3500-S							1.17	0.20
E0850-075-2250-M					2.250	57.15	3.97	100.84					9.7	1.699	E0850-075-2250-S							8.08	1.42
E0850-075-2500-M					2.500	63.50	4.71	119.63					7.5	1.313	E0850-075-2500-S							6.25	1.09
E0850-075-2750-M					2.750	69.85	5.54	140.72					6.0	1.051	E0850-075-2750-S							5.00	0.88
E0850-075-3000-M			0.075	1.91	3.000	76.20	6.36	161.54	18.40	81.85	1.70	7.56	5.0	0.876	E0850-075-3000-S	15.33	68.18	1.42	6.30		4.17	0.73	
E0850-075-3500-M					3.500	88.90	7.93	201.42					3.8	0.665	E0850-075-3500-S							3.17	0.55
E0850-075-4000-M	0.850	21.59			4.000	101.60	9.49	241.05					3.0	0.525	E0850-075-4000-S							2.50	0.44
E0850-075-4500-M					4.500	114.30	11.14	282.96					2.5	0.438	E0850-075-4500-S							2.08	0.37
E0850-075-5000-M					5.000	127.00	12.71	322.83					2.2	0.385	E0850-075-5000-S							1.83	0.32
E0850-085-2000-M					2.000	50.80	2.73	69.34					34.0	5.950	E0850-085-2000-S							28.32	4.96
E0850-085-2250-M					2.250	57.15	3.52	89.41					19.2	3.360	E0850-085-2250-S							15.99	2.80
E0850-085-2500-M					2.500	63.50	4.18	106.17					14.0	2.450	E0850-085-2500-S							11.66	2.04
E0850-085-2750-M					2.750	69.85	4.83	122.68					11.3	1.979	E0850-085-2750-S							9.41	1.65
E0850-085-3000-M					3.000	76.20	5.49	139.45					9.5	1.664	E0850-085-3000-S							7.91	1.39
E0850-085-3500-M			0.085	2.16	3.500	88.90	6.73	170.94	25.90	115.21	2.40	10.68	7.3	1.278	E0850-085-3500-S	21.58	95.97	2.00	8.90		6.08	1.07	
E0850-085-4000-M					4.000	101.60	8.03	203.96					5.8	1.016	E0850-085-4000-S							4.83	0.85
E0850-085-4500-M					4.500	114.30	9.34	237.24					4.9	0.858	E0850-085-4500-S							4.08	0.72
E0850-085-4750-M					4.750	120.65	9.99	253.75					4.5	0.788	E0850-085-4750-S							3.75	0.66
E0850-085-5000-M					5.000	127.00	10.64	270.26					4.2	0.736	E0850-085-5000-S							3.50	0.61
E0850-085-5500-M					5.500	139.70	12.36	313.94					3.6	0.630	E0850-085-5500-S							3.00	0.53
E0850-085-6000-M					6.000	152.40	13.73	348.74					3.2	0.560	E0850-085-6000-S							2.67	0.47
T32370					2.000	50.80	3.760	95.50					11.6	2.030	T42370							9.66	1.69
T32380					2.472	62.80	5.287	134.30					7.3	1.270	T42380							6.08	1.06
T32390	0.866	22.00	0.079	2.00	3.181	80.80	7.591	192.80	24.05	107.00	3.61	16.07	4.6	0.810	T42390	20.04	89.13	3.01	13.38		3.83	0.68	
T32400					4.370	111.00	11.417	290.00					2.9	0.510	T42400							2.42	0.43
T32410					5.945	151.00	16.496	419.00					1.9	0.340	T42410							1.58	0.28
T32810			0.126	3.20	2.370	60.20	3.177	80.70	86.77	386.00	12.76	56.75	91.9	16.100	T42810	72.28	321.54	10.63	47.27		76.55	13.41	

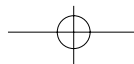

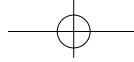

MUSIC WIRE 乐器金属弦线												STAINLESS STEEL 不锈钢金属线												
Catalog Number 编号	Outside Diameter (OD) 外径 (OD)		Wire Diameter (d) 线径 (d)		Free Length L ₁ , Approx 自由长度L ₁ (估算值)		Ext. L ₁ 拉伸长度L ₁		Load P at L ₁ L ₁ 下的承载 载荷P		Initial Tension T (Ref. only) 初始张力T (仅供参考)		Spring Rate R 弹性系数R		Catalog Number 编号	Load P at L ₁ L ₁ 下的承载 载荷P		Initial Tension T (Ref. only) 初始张力T (仅供参考)		Spring Rate R 弹性系数R				
	in	mm	in	mm	in	mm	in	mm	lb	N	lb	N	lb/in	N/mm		lb	N	lb	N	lb/in	N/mm			
T32820					3.126	79.40	4.413	112.10					57.1	10.000	T42820								47.56	8.33
T32830			0.126	3.20	4.252	108.00	6.264	159.10	86.77	386.00	12.76	56.75	37.0	6.480	T42830	72.28	321.54	10.63	47.27	30.82	5.40			
T32840	0.866	22.00			6.142	156.00	9.362	237.80					23.0	4.020	T42840					19.16	3.35			
T33140					2.768	70.30	3.177	80.70					444.8	77.900	T43140							370.52	64.89	
T33150			0.177	4.50	3.831	97.30	4.484	113.90	213.78	951.00	31.95	142.11	278.1	48.700	T43150	178.08	792.18	26.61	118.38	231.66	40.57			
T33160					5.433	138.00	6.453	163.90					178.2	31.200	T43160					148.44	25.99			
T32490					2.189	55.60	4.043	102.70					13.2	2.310	T42490							11.00	1.92	
T32500					2.709	68.80	5.673	144.10					8.2	1.440	T42500							6.83	1.20	
T32510	0.945	24.00	0.087	2.20	3.488	88.60	8.134	206.60	28.55	127.00	4.18	18.60	5.3	0.920	T42510	23.78	105.79	3.48	15.50	4.41	0.77			
T32520					4.803	122.00	12.205	310.00					3.3	0.580	T42520							2.75	0.48	
T32530					6.535	166.00	17.638	448.00					2.2	0.380	T42530							1.83	0.32	
T32930					2.681	68.10	3.587	91.10					99.9	17.500	T42930							83.22	14.58	
T32940			0.142	3.60	3.531	89.70	4.980	126.50	106.33	473.00	15.95	70.96	62.2	10.900	T42940	88.57	394.01	13.29	59.11	51.81	9.08			
T32950					4.803	122.00	7.071	179.60					39.9	6.980	T42950							33.24	5.81	
T32960	0.984	25.00			6.929	176.00	10.555	268.10					25.0	4.370	T42960							20.83	3.64	
T33260					3.110	79.00	3.579	90.90					453.9	79.500	T43260							378.10	66.22	
T33270			0.197	5.00	4.291	109.00	5.039	128.00	249.53	1110.00	37.11	165.06	283.8	49.700	T43270	207.86	924.63	30.91	137.50	236.41	41.40			
T33280					6.063	154.00	7.232	183.70					181.6	31.800	T43280							151.27	26.49	
E1000-063-2500-M					2.500	63.50	5.91	150.11					2.6	0.455	E1000-063-2500-S							2.17	0.38	
E1000-063-2750-M			0.063	1.60	2.750	69.85	7.40	187.96	9.70		0.90	4.00	1.9	0.333	E1000-063-2750-S	8.08	35.94	0.75	3.33	1.58	0.28			
E1000-063-3000-M					3.000	76.20	8.89	225.81		43.15			1.5	0.263	E1000-063-3000-S							1.25	0.22	
E1000-063-3250-M					3.250	82.55	10.38	263.65					1.2	0.210	E1000-063-3250-S							1.00	0.18	
E1000-075-2500-M					2.500	63.50	4.77	121.16					6.3	1.103	E1000-075-2500-S							5.25	0.92	
E1000-075-2750-M					2.750	69.85	5.85	148.59					4.6	0.806	E1000-075-2750-S							3.83	0.67	
E1000-075-3000-M					3.000	76.20	6.94	176.28					3.6	0.630	E1000-075-3000-S							3.00	0.53	
E1000-075-3500-M			0.075	1.91	3.500	88.90	8.99	228.35	15.70		1.40	6.23	2.6	0.455	E1000-075-3500-S	13.08	58.18	1.17	5.19	2.17	0.38			
E1000-075-4000-M					4.000	101.60	11.04	280.42		69.84			2.0	0.350	E1000-075-4000-S							1.67	0.29	
E1000-075-4500-M					4.500	114.30	13.21	335.53					1.7	0.298	E1000-075-4500-S							1.42	0.25	
E1000-075-5000-M					5.000	127.00	15.26	387.60					1.4	0.245	E1000-075-5000-S							1.17	0.20	
E1000-085-2500-M					2.500	63.50	4.01	101.85					14.1	2.470	E1000-085-2500-S							11.75	2.06	
E1000-085-2750-M					2.750	69.85	5.12	130.05					8.5	1.489	E1000-085-2750-S							7.08	1.24	
E1000-085-3000-M					3.000	76.20	5.96	151.38					6.8	1.191	E1000-085-3000-S							5.66	0.99	
E1000-085-3500-M			0.085	2.16	3.500	88.90	7.55	191.77	22.20		2.00	8.90	5.0	0.876	E1000-085-3500-S	18.49	82.26	1.67	7.41	4.17	0.73			
E1000-085-4000-M					4.000	101.60	9.23	234.44		98.75			3.9	0.683	E1000-085-4000-S							3.25	0.57	
E1000-085-4500-M					4.500	114.30	10.92	277.37					3.2	0.560	E1000-085-4500-S							2.67	0.47	
E1000-085-5000-M					5.000	127.00	12.60	320.04					2.7	0.473	E1000-085-5000-S							2.25	0.39	
E1000-095-2500-M					2.500	63.50	3.71	94.23					24.1	4.220	E1000-095-2500-S							20.08	3.52	
E1000-095-2750-M					2.750	69.85	4.57	116.08					15.0	2.630	E1000-095-2750-S							12.50	2.19	
E1000-095-3000-M					3.000	76.20	5.24	133.10					12.2	2.140	E1000-095-3000-S							10.16	1.78	
E1000-095-3500-M	1.000	25.40			3.500	88.90	6.65	168.91					8.7	1.524	E1000-095-3500-S							7.25	1.27	
E1000-095-4000-M					4.000	101.60	7.98	202.69					6.9	1.208	E1000-095-4000-S							5.75	1.01	
E1000-095-4500-M					4.500	114.30	9.39	238.51					5.6	0.981	E1000-095-4500-S							4.66	0.82	
E1000-095-5000-M			0.095	2.41	5.000	127.00	10.72	272.29	30.00		2.70	12.01	4.8	0.841	E1000-095-5000-S	24.99	111.16	2.25	10.00	4.00	0.70			
E1000-095-5500-M					5.500	139.70	12.53	318.26		133.45			4.1	0.718	E1000-095-5500-S							3.42	0.60	
E1000-095-6000-M					6.000	152.40	14.00	355.60					3.6	0.630	E1000-095-6000-S							3.00	0.53	
E1000-095-6500-M					6.500	165.10	14.88	377.95					3.3	0.578	E1000-095-6500-S							2.75	0.48	
E1000-095-7000-M					7.000	177.80	16.33	414.78					2.9	0.508	E1000-095-7000-S							2.42	0.42	
E1000-095-8000-M					8.000	203.20	19.15	486.41					2.4	0.420	E1000-095-8000-S							2.00	0.35	
E1000-095-9000-M					9.000	228.60	21.96	557.78					2.1	0.368	E1000-095-9000-S							1.75	0.31	
E1000-105-2500-M					2.500	63.50	3.49	88.65					39.0	6.830	E1000-105-2500-S							32.49	5.69	
E1000-105-2750-M					2.750	69.85	4.11	104.39					28.2	4.940	E1000-105-2750-S							23.49	4.12	
E1000-105-3000-M					3.000	76.20	4.74	120.40					22.1	3.870	E1000-105-3000-S							18.41	3.22	
E1000-105-3500-M					3.500	88.90	5.99	152.15					15.4	2.700	E1000-105-3500-S							12.83	2.25	
E1000-105-4000-M					4.000	101.60	7.24	183.90					11.9	2.080	E1000-105-4000-S							9.91	1.73	
E1000-105-4500-M			0.105	2.67	4.500	114.30	8.49	215.65	42.25		3.80	16.90	9.6	1.681	E1000-105-4500-S	35.19	156.55	3.17	14.08	8.00	1.40			
E1000-105-5000-M					5.000	127.00	9.74	247.40		187.94			8.1	1.419	E1000-105-5000-S							6.75	1.18	
E1000-105-5500-M					5.500	139.70	10.99	279.15					7.0	1.226	E1000-105-5500-S							5.83	1.02	
E1000-105-6000-M					6.000	152.40	12.25	311.15					6.2	1.086	E1000-105-6000-S							5.16	0.91	
E1000-105-6500-M					6.500	165.10	13.52	343.41					5.5	0.963	E1000-105-6500-S							4.58	0.80	
E1000-105-7000-M					7.000	177.80	14.73	374.14					5.0	0.876	E1000-105-7000-S							4.17	0.73	
E1000-105-8000-M					8.000	203.20	17.23	437.64					4.2	0.736	E1000-105-8000-S							3.50	0.61	

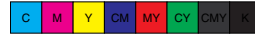
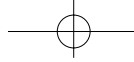

MUSIC WIRE 乐器金属弦线												STAINLESS STEEL 不锈钢金属线											
Catalog Number 编号	Outside Diameter (OD) 外径 (OD)		Wire Diameter (d) 线径 (d)		Free Length L ₁ , Approx 自由长度L ₁ (估算值)		Ext. L ₁ 拉伸长度L ₁		Load P at L ₁ L ₁ 下的承载 载荷P		Initial Tension T (Ref. only) 初始张力T (仅供参考)		Spring Rate R 弹性系数R		Catalog Number 编号	Load P at L ₁ L ₁ 下的承载 载荷P		Initial Tension T (Ref. only) 初始张力T (仅供参考)		Spring Rate R 弹性系数R			
	in	mm	in	mm	in	mm	in	mm	lb	N	lb	N	lb/in	N/mm		lb	N	lb	N	lb/in	N/mm		
E1000-105-9000-M			0.105	2.67	9.000	228.60	19.73	501.14	42.25	187.94	3.80	16.90	3.6	0.630	E1000-105-9000-S	35.19	156.55	3.17	14.08	3.00	0.53		
E1000-115-2500-M					2.500	63.50	3.32	84.33					60.4	10.580	E1000-115-2500-S					50.31	8.81		
E1000-115-2750-M					2.750	69.85	3.87	98.30					44.3	7.760	E1000-115-2750-S					36.90	6.46		
E1000-115-3000-M					3.000	76.20	4.41	112.01					35.0	6.130	E1000-115-3000-S					29.16	5.11		
E1000-115-3500-M					3.500	88.90	5.50	139.70					24.7	4.330	E1000-115-3500-S					20.58	3.61		
E1000-115-4000-M					4.000	101.60	6.60	167.64					19.0	3.330	E1000-115-4000-S					15.83	2.77		
E1000-115-4500-M					4.500	114.30	7.69	195.33					15.5	2.710	E1000-115-4500-S					12.91	2.26		
E1000-115-5000-M			0.115	2.92	5.000	127.00	8.78	223.01	54.30	241.54	4.90	21.80	13.1	2.290	E1000-115-5000-S	45.23	201.20	4.08	18.16	10.91	1.91		
E1000-115-5500-M					5.500	139.70	9.87	250.70					11.3	1.979	E1000-115-5500-S					9.41	1.65		
E1000-115-6000-M					6.000	152.40	10.97	278.64					10.0	1.751	E1000-115-6000-S					8.33	1.46		
E1000-115-6500-M					6.500	165.10	12.08	306.83					8.8	1.541	E1000-115-6500-S					7.33	1.28		
E1000-115-7000-M					7.000	177.80	13.13	333.50					8.1	1.419	E1000-115-7000-S					6.75	1.18		
E1000-115-8000-M					8.000	203.20	15.35	389.89					6.7	1.173	E1000-115-8000-S					5.58	0.98		
E1000-115-9000-M					9.000	228.60	17.51	444.75					5.8	1.016	E1000-115-9000-S					4.83	0.85		
E1000-125-2500-M					2.500	63.50	3.21	81.53					87.3	15.290	E1000-125-2500-S					72.72	12.74		
E1000-125-2750-M					2.750	69.85	3.69	93.73					65.5	11.470	E1000-125-2750-S					54.56	9.56		
E1000-125-3000-M					3.000	76.20	4.18	106.17					52.4	9.180	E1000-125-3000-S					43.65	7.65		
E1000-125-3500-M					3.500	88.90	5.15	130.81					37.4	6.550	E1000-125-3500-S					31.15	5.46		
E1000-125-4000-M					4.000	101.60	6.12	155.45					29.1	5.100	E1000-125-4000-S					24.24	4.25		
E1000-125-4500-M					4.500	114.30	7.09	180.09					23.8	4.170	E1000-125-4500-S					19.83	3.47		
E1000-125-5000-M			0.125	3.18	5.000	127.00	8.07	204.98	67.87	301.89	6.11	27.18	20.1	3.520	E1000-125-5000-S	56.54	251.47	5.09	22.64	16.74	2.93		
E1000-125-5500-M					5.500	139.70	9.04	229.62					17.5	3.060	E1000-125-5500-S					14.58	2.55		
E1000-125-6000-M					6.000	152.40	10.01	254.25					15.4	2.700	E1000-125-6000-S					12.83	2.25		
E1000-125-6500-M					6.500	165.10	10.98	278.89					13.8	2.420	E1000-125-6500-S					11.50	2.02		
E1000-125-7000-M					7.000	177.80	11.95	303.53					12.5	2.190	E1000-125-7000-S					10.41	1.82		
E1000-125-8000-M					8.000	203.20	13.89	352.81					10.5	1.839	E1000-125-8000-S					8.75	1.53		
E1000-125-9000-M	1.000	25.40			9.000	228.60	15.84	402.34					9.0	1.576	E1000-125-9000-S					7.50	1.31		
E1000-135-2500-M					2.500	63.50	3.07	77.98					134.1	23.480	E1000-135-2500-S					111.71	19.56		
E1000-135-2750-M					2.750	69.85	3.53	89.66					98.4	17.230	E1000-135-2750-S					81.97	14.35		
E1000-135-3000-M					3.000	76.20	3.98	101.09					77.7	13.610	E1000-135-3000-S					64.72	11.34		
E1000-135-3500-M					3.500	88.90	4.85	123.19					56.7	9.930	E1000-135-3500-S					47.23	8.27		
E1000-135-4000-M					4.000	101.60	5.71	145.03					44.7	7.830	E1000-135-4000-S					37.24	6.52		
E1000-135-4500-M					4.500	114.30	6.62	168.15					36.0	6.300	E1000-135-4500-S					29.99	5.25		
E1000-135-5000-M			0.135	3.43	5.000	127.00	7.49	190.25	83.98	373.54	7.56	33.63	30.7	5.380	E1000-135-5000-S	69.96	311.16	6.30	28.01	25.57	4.48		
E1000-135-5500-M					5.500	139.70	8.40	213.36					26.3	4.610	E1000-135-5500-S					21.91	3.84		
E1000-135-6000-M					6.000	152.40	9.26	235.20					23.4	4.100	E1000-135-6000-S					19.49	3.42		
E1000-135-6500-M					6.500	165.10	10.18	258.57					20.8	3.640	E1000-135-6500-S					17.33	3.03		
E1000-135-7000-M					7.000	177.80	11.04	280.42					18.9	3.310	E1000-135-7000-S					15.74	2.76		
E1000-135-8000-M					8.000	203.20	12.82	325.63					15.9	2.780	E1000-135-8000-S					13.24	2.32		
E1000-135-9000-M					9.000	228.60	14.59	370.59					13.7	2.400	E1000-135-9000-S					11.41	2.00		
E1000-148-2500-M					2.500	63.50	2.98	75.69					202.8	35.510	E1000-148-2500-S					168.93	29.58		
E1000-148-2750-M					2.750	69.85	3.36	85.34					159.3	27.890	E1000-148-2750-S					132.70	23.23		
E1000-148-3000-M					3.000	76.20	3.79	96.27					123.9	21.700	E1000-148-3000-S					103.21	18.08		
E1000-148-3500-M					3.500	88.90	4.55	115.57					92.9	16.270	E1000-148-3500-S					77.39	13.55		
E1000-148-4000-M					4.000	101.60	5.36	136.14					71.9	12.590	E1000-148-4000-S					59.89	10.49		
E1000-148-4500-M					4.500	114.30	6.17	156.72					58.7	10.280	E1000-148-4500-S					48.90	8.56		
E1000-148-5000-M			0.148	3.76	5.000	127.00	6.98	177.29	107.57	478.47	9.68	43.06	49.6	8.690	E1000-148-5000-S	89.61	398.57	8.06	35.87	41.32	7.24		
E1000-148-5500-M					5.500	139.70	7.74	196.60					43.7	7.650	E1000-148-5500-S					36.40	6.37		
E1000-148-6000-M					6.000	152.40	8.55	217.17					38.5	6.740	E1000-148-6000-S					32.07	5.61		
E1000-148-6500-M					6.500	165.10	9.35	237.49					34.3	6.010	E1000-148-6500-S					28.57	5.01		
E1000-148-7000-M					7.000	177.80	10.16	258.06					31.0	5.430	E1000-148-7000-S					25.82	4.52		
E1000-148-8000-M					8.000	203.20	11.73	297.94					26.2	4.590	E1000-148-8000-S					21.82	3.82		
E1000-148-9000-M					9.000	228.60	13.35	339.09					22.5	3.940	E1000-148-9000-S					18.74	3.28		
T32610					2.531	64.30	4.720	119.90					13.6	2.390	T42610					11.33	1.99		
T32620					3.122	79.30	6.622	168.20					8.6	1.500	T42620					7.16	1.25		
T32630			0.098	2.50	4.016	102.00	9.488	241.00	35.29	157.00	5.35	23.79	5.5	0.960	T42630	29.40	130.78	4.45	19.81	4.58	0.80		
T32640					5.472	139.00	14.213	361.00					3.4	0.600	T42640					2.83	0.50		
T32650	1.102	28.00			7.441	189.00	20.551	522.00					2.3	0.400	T42650					1.92	0.33		
T33050					2.992	76.00	3.992	101.40					107.3	18.800	T43050					89.38	15.66		
T33060			0.157	4.00	3.937	100.00	5.539	140.70	126.79	564.00	19.01	84.56	67.4	11.800	T43060	105.61	469.81	15.84	70.44	56.14	9.83		
T33070					5.354	136.00	7.858	199.60					43.1	7.540	T43070					35.90	6.28		

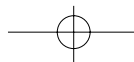

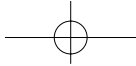

MUSIC WIRE 乐器金属弦线														STAINLESS STEEL 不锈钢金属线									
Catalog Number 编号	Outside Diameter (OD) 外径 (OD)		Wire Diameter (d) 线径 (d)		Free Length L ₁ , Approx 自由长度L ₁ (估算值)		Ext. L ₁ 拉伸长度L ₁		Load P at L ₁ L ₁ 下的承载 载荷P		Initial Tension T (Ref. only) 初始张力T (仅供参考)		Spring Rate R 弹性系数 R		Catalog Number 编号	Load P at L ₁ L ₁ 下的承载 载荷P		Initial Tension T (Ref. only) 初始张力T (仅供参考)		Spring Rate R 弹性系数 R			
	in	mm	in	mm	in	mm	in	mm	lb	N	lb	N	lb/in	N/mm		lb	N	lb	N	lb/in	N/mm		
T33080	1.102	28.00	0.157	4.00	7.717	196.00	11.732	298.00	126.79	564.00	19.01	84.56	26.9	4.710	T43080	105.61	469.81	15.84	70.44	22.41	3.92		
E1125-085-3000-M					3.000	76.20	5.74	145.80					7.0	1.226	E1125-085-3000-S					5.83	1.02		
E1125-085-3500-M					3.500	88.90	7.92	201.17					4.3	0.753	E1125-085-3500-S					3.58	0.63		
E1125-085-4000-M					4.000	101.60	10.11	256.79					3.1	0.543	E1125-085-4000-S					2.58	0.45		
E1125-085-4500-M					4.500	114.30	12.29	312.17					2.5	0.438	E1125-085-4500-S					2.08	0.37		
E1125-085-5000-M			0.085	2.16	5.000	127.00	14.47	367.54	20.97	93.28	1.89	8.41	2.0	0.350	E1125-085-5000-S	17.47	77.70	1.58	7.01	1.67	0.29		
E1125-085-5500-M					5.500	139.70	16.65	422.91					1.7	0.298	E1125-085-5500-S					1.42	0.25		
E1125-085-6000-M					6.000	152.40	18.84	478.54					1.5	0.263	E1125-085-6000-S					1.25	0.22		
E1125-085-6500-M					6.500	165.10	21.02	533.91					1.3	0.228	E1125-085-6500-S					1.08	0.19		
E1125-085-7000-M					7.000	177.80	23.20	589.28					1.2	0.210	E1125-085-7000-S					1.00	0.18		
E1125-105-3000-M					3.000	76.20	4.75	120.65					19.6	3.430	E1125-105-3000-S					16.33	2.86		
E1125-105-3500-M					3.500	88.90	6.25	158.75					12.5	2.190	E1125-105-3500-S					10.41	1.82		
E1125-105-4000-M					4.000	101.60	7.74	196.60					9.2	1.611	E1125-105-4000-S					7.66	1.34		
E1125-105-4500-M					4.500	114.30	9.24	234.70					7.3	1.278	E1125-105-4500-S					6.08	1.07		
E1125-105-5000-M	1.125	28.58	0.105	2.67	5.000	127.00	10.73	272.54	37.80	168.14	3.40	15.12	6.0	1.051	E1125-105-5000-S	31.49	140.06	2.83	12.59	5.00	0.88		
E1125-105-5500-M					5.500	139.70	12.23	310.64					5.1	0.893	E1125-105-5500-S					4.25	0.74		
E1125-105-6000-M					6.000	152.40	13.72	348.49					4.5	0.788	E1125-105-6000-S					3.75	0.66		
E1125-105-6500-M					6.500	165.10	15.22	386.59					3.9	0.683	E1125-105-6500-S					3.25	0.57		
E1125-105-7000-M					7.000	177.80	16.71	424.43					3.5	0.613	E1125-105-7000-S					2.92	0.51		
E1125-125-3000-M					3.000	76.20	4.21	106.93					46.2	8.090	E1125-125-3000-S					38.48	6.74		
E1125-125-3500-M					3.500	88.90	5.34	135.64					30.3	5.310	E1125-125-3500-S					25.24	4.42		
E1125-125-4000-M					4.000	101.60	6.48	164.59					22.5	3.940	E1125-125-4000-S					18.74	3.28		
E1125-125-4500-M					4.500	114.30	7.61	193.29					17.9	3.130	E1125-125-4500-S					14.91	2.61		
E1125-125-5000-M			0.125	3.18	5.000	127.00	8.75	222.25	61.25	272.45	5.51	24.51	14.9	2.610	E1125-125-5000-S	51.02	226.95	4.59	20.42	12.41	2.17		
E1125-125-5500-M					5.500	139.70	9.88	250.95					12.7	2.220	E1125-125-5500-S					10.58	1.85		
E1125-125-6000-M					6.000	152.40	11.02	279.91					11.1	1.944	E1125-125-6000-S					9.25	1.62		
E1125-125-6500-M					6.500	165.10	12.15	308.61					9.9	1.734	E1125-125-6500-S					8.25	1.44		
E1125-125-7000-M					7.000	177.80	13.29	337.57					8.9	1.559	E1125-125-7000-S					7.41	1.30		
T32730					2.748	69.80	4.902	124.50					17.8	3.110	T42730					14.83	2.59		
T32740	1.181	30.00	0.110	2.80	3.409	86.60	6.858	174.20	44.96	200.00	6.62	29.47	11.1	1.940	T42740	37.45	166.60	5.74	25.55	9.25	1.62		
T32750					4.409	112.00	9.803	249.00					7.1	1.250	T42750					5.91	1.04		
T32760					6.063	154.00	14.685	373.00					4.5	0.780	T42760					3.75	0.65		
E1250-095-3500-M					3.500	88.90	7.00	177.80					6.7	1.173	E1250-095-3500-S					5.58	0.98		
E1250-095-4000-M					4.000	101.60	9.13	231.90					4.6	0.806	E1250-095-4000-S					3.83	0.67		
E1250-095-4500-M					4.500	114.30	11.26	286.00					3.5	0.613	E1250-095-4500-S					2.92	0.51		
E1250-095-5000-M					5.000	127.00	13.39	340.11					2.8	0.490	E1250-095-5000-S					2.33	0.41		
E1250-095-5500-M			0.095	2.41	5.500	139.70	15.52	394.21	25.86	115.03	2.33	10.36	2.3	0.403	E1250-095-5500-S	21.54	95.82	1.94	8.63	1.92	0.34		
E1250-095-6000-M					6.000	152.40	17.65	448.31					2.0	0.350	E1250-095-6000-S					1.67	0.29		
E1250-095-6500-M					6.500	165.10	19.78	502.41					1.8	0.315	E1250-095-6500-S					1.50	0.26		
E1250-095-7500-M					7.500	190.50	24.04	610.62					1.4	0.245	E1250-095-7500-S					1.17	0.20		
E1250-115-3500-M					3.500	88.90	5.81	147.57					17.3	3.030	E1250-115-3500-S					14.41	2.52		
E1250-115-4000-M					4.000	101.60	7.32	185.93					12.1	2.120	E1250-115-4000-S					10.08	1.77		
E1250-115-4500-M					4.500	114.30	8.84	224.54					9.2	1.611	E1250-115-4500-S					7.66	1.34		
E1250-115-5000-M					5.000	127.00	10.35	262.89					7.5	1.313	E1250-115-5000-S					6.25	1.09		
E1250-115-5500-M			0.115	2.92	5.500	139.70	11.86	301.24	44.03	195.86	3.96	17.61	6.3	1.103	E1250-115-5500-S	36.68	163.15	3.30	14.67	5.25	0.92		
E1250-115-6000-M					6.000	152.40	13.38	339.85					5.4	0.946	E1250-115-6000-S					4.50	0.79		
E1250-115-6500-M	1.250	31.75			6.500	165.10	14.89	378.21					4.8	0.841	E1250-115-6500-S					4.00	0.70		
E1250-115-7000-M					7.000	177.80	16.40	416.56					4.3	0.753	E1250-115-7000-S					3.58	0.63		
E1250-115-7500-M					7.500	190.50	17.92	455.17					3.8	0.665	E1250-115-7500-S					3.17	0.55		
E1250-135-3500-M					3.500	88.90	5.12	130.05					38.5	6.740	E1250-135-3500-S					32.07	5.61		
E1250-135-4000-M					4.000	101.60	6.30	160.02					27.2	4.760	E1250-135-4000-S					22.66	3.97		
E1250-135-4500-M					4.500	114.30	7.47	189.74					21.1	3.700	E1250-135-4500-S					17.58	3.08		
E1250-135-5000-M					5.000	127.00	8.64	219.46					17.2	3.010	E1250-135-5000-S					14.33	2.51		
E1250-135-5500-M			0.135	3.43	5.500	139.70	9.81	249.17	68.62	305.24	6.18	27.49	14.5	2.540	E1250-135-5500-S	57.16	254.26	5.15	22.90	12.08	2.12		
E1250-135-6000-M					6.000	152.40	10.98	278.89					12.5	2.190	E1250-135-6000-S					10.41	1.82		
E1250-135-6500-M					6.500	165.10	12.15	308.61					11.0	1.926	E1250-135-6500-S					9.16	1.60		
E1250-135-7000-M					7.000	177.80	13.32	338.33					9.9	1.734	E1250-135-7000-S					8.25	1.44		
E1250-135-7500-M					7.500	190.50	14.50	368.30					8.9	1.559	E1250-135-7500-S					7.41	1.30		
E1250-148-3500-M					3.500	88.90	4.82	122.43															

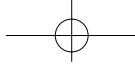

MUSIC WIRE 乐器金属弦线												STAINLESS STEEL 不锈钢金属线											
Catalog Number 编号	Outside Diameter (OD) 外径 (OD)		Wire Diameter (d) 线径 (d)		Free Length L, Approx 自由长度L (估算值)		Ext. L ₁ 拉伸长度L ₁		Load P at L ₁ L ₁ 下的承载 载荷P		Initial Tension T (Ref. only) 初始张力T (仅供参考)		Spring Rate R 弹性系数R		Catalog Number 编号	Load P at L ₁ L ₁ 下的承载 载荷P		Initial Tension T (Ref. only) 初始张力T (仅供参考)		Spring Rate R 弹性系数R			
	in	mm	in	mm	in	mm	in	mm	lb	N	lb	N	lb/in	N/mm		lb	N	lb	N	lb/in	N/mm		
E1250-148-5000-M					5.000	127.00	7.90	200.66					27.7	4.850	E1250-148-5000-S							23.07	4.04
E1250-148-5500-M					5.500	139.70	8.93	226.82					23.4	4.100	E1250-148-5500-S							19.49	3.42
E1250-148-6000-M	1.250	31.75	0.148	3.76	6.000	152.40	9.96	252.98	88.38	393.13	7.95	35.36	20.3	3.560	E1250-148-6000-S	73.62	327.48	6.62	29.45	16.91	2.97		
E1250-148-6500-M					6.500	165.10	10.99	279.15					17.9	3.130	E1250-148-6500-S							14.91	2.61
E1250-148-7000-M					7.000	177.80	12.01	305.05					16.0	2.800	E1250-148-7000-S							13.33	2.33
E1250-148-7500-M					7.500	190.50	13.04	331.22					14.5	2.540	E1250-148-7500-S							12.08	2.12
T33170					3.398	86.30	4.539	115.30					114.8	20.100	T43170							95.60	16.74
T33180	1.260	32.00	0.177	4.50	4.449	113.00	6.276	159.40	153.99	685.00	22.95	102.08	71.9	12.600	T43180	128.27	570.61	19.12	85.03	59.93	10.50		
T33190					6.063	154.00	8.921	226.60					45.9	8.030	T43190							38.19	6.69
T33200					8.701	221.00	13.268	337.00					28.6	5.010	T43200							23.83	4.17
T32850					3.252	82.60	5.945	151.00					17.2	3.020	T42850							14.36	2.52
T32860					4.016	102.00	8.307	211.00					10.8	1.890	T42860							8.99	1.57
T32870			0.126	3.20	5.157	131.00	11.890	302.00	54.63	243.00	8.19	36.45	6.9	1.210	T42870	45.50	202.42	6.83	30.37	5.76	1.01		
T32880					7.047	179.00	17.835	453.00					4.3	0.760	T42880							3.61	0.63
T32890	1.417	36.00			9.567	243.00	25.709	653.00					2.9	0.500	T42890							2.38	0.42
T33290					3.803	96.60	5.071	128.80					122.2	21.400	T43290							101.79	17.83
T33300			0.197	5.00	5.000	127.00	7.028	178.50	181.64	808.00	27.12	120.62	75.9	13.300	T43300	151.31	673.06	22.59	100.48	63.26	11.08		
T33310					6.772	172.00	9.937	252.40					48.8	8.540	T43310							40.62	7.11
T33320					9.724	247.00	14.803	376.00					30.5	5.340	T43320							25.40	4.45
E1500-125-4500-M					4.500	114.30	8.59	218.19					10.4	1.821	E1500-125-4500-S							8.66	1.52
E1500-125-5000-M					5.000	127.00	10.34	262.64					7.9	1.384	E1500-125-5000-S							6.58	1.15
E1500-125-5500-M					5.500	139.70	12.10	307.34					6.4	1.121	E1500-125-5500-S							5.33	0.93
E1500-125-6000-M			0.125	3.18	6.000	152.40	13.86	352.04	46.64	207.47	4.20	18.68	5.4	0.946	E1500-125-6000-S	38.85	172.82	3.50	15.56	4.50	0.79		
E1500-125-6500-M					6.500	165.10	15.62	396.75					4.7	0.823	E1500-125-6500-S							3.92	0.69
E1500-125-7000-M					7.000	177.80	17.37	441.20					4.1	0.718	E1500-125-7000-S							3.42	0.60
E1500-125-7500-M					7.500	190.50	19.13	485.90					3.6	0.631	E1500-125-7500-S							3.00	0.53
E1500-125-8000-M					8.000	203.20	20.89	530.61					3.3	0.578	E1500-125-8000-S							2.75	0.48
E1500-148-4500-M					4.500	114.30	7.30	185.42					24.3	4.260	E1500-148-4500-S							20.24	3.55
E1500-148-5000-M					5.000	127.00	8.62	218.95					18.7	3.270	E1500-148-5000-S							15.58	2.72
E1500-148-5500-M					5.500	139.70	9.94	252.48					15.3	2.680	E1500-148-5500-S							12.74	2.23
E1500-148-6000-M					6.000	152.40	11.26	286.00					12.9	2.260	E1500-148-6000-S							10.75	1.88
E1500-148-6500-M	1.500	38.10	0.148	3.76	6.500	165.10	12.58	319.53	74.49	331.35	6.70	29.80	11.2	1.961	E1500-148-6500-S	62.05	276.01	5.58	24.82	9.33	1.63		
E1500-148-7000-M					7.000	177.80	13.90	353.06					9.8	1.716	E1500-148-7000-S							8.16	1.43
E1500-148-7500-M					7.500	190.50	15.22	386.59					8.8	1.541	E1500-148-7500-S							7.33	1.28
E1500-148-8000-M					8.000	203.20	16.54	420.12					7.9	1.384	E1500-148-8000-S							6.58	1.15
E1500-177-4500-M					4.500	114.30	6.35	161.29					59.9	10.490	E1500-177-4500-S							49.90	8.74
E1500-177-5000-M					5.000	127.00	7.37	187.20					46.9	8.210	E1500-177-5000-S							39.07	6.84
E1500-177-5500-M					5.500	139.70	8.38	212.85					38.5	6.740	E1500-177-5500-S							32.07	5.61
E1500-177-6000-M			0.177	4.50	6.000	152.40	9.40	238.76	121.90	542.24	10.97	48.79	32.7	5.730	E1500-177-6000-S	101.54	451.69	9.14	40.64	27.24	4.77		
E1500-177-6500-M					6.500	165.10	10.41	264.41					28.4	4.970	E1500-177-6500-S							23.66	4.14
E1500-177-7000-M					7.000	177.80	11.42	290.07					25.1	4.400	E1500-177-7000-S							20.91	3.67
E1500-177-7500-M					7.500	190.50	12.44	315.98					22.5	3.940	E1500-177-7500-S							18.74	3.28
E1500-177-8000-M					8.000	203.20	13.45	341.63					20.3	3.560	E1500-177-8000-S							16.91	2.97
T32970					3.626	92.10	6.496	165.00					20.2	3.540	T42970							16.84	2.95
T32980					4.488	114.00	9.094	231.00					12.7	2.220	T42980							10.56	1.85
T32990	1.575	40.00	0.142	3.60	5.748	146.00	12.913	328.00	68.34	304.00	10.29	45.79	8.1	1.420	T42990	56.93	253.23	8.58	38.15	6.75	1.18		
T33000					7.874	200.00	19.370	492.00					5.0	0.880	T43000							4.19	0.73
T33010					10.709	272.00	27.913	709.00					3.4	0.590	T43010							2.81	0.49
E1750-148-5000-M					5.000	127.00	8.90	226.06					15.0	2.630	E1750-148-5000-S							12.50	2.19
E1750-148-5500-M					5.500	139.70	10.58	268.73					11.5	2.010	E1750-148-5500-S							9.58	1.67
E1750-148-6000-M					6.000	152.40	12.26	311.40					9.4	1.646	E1750-148-6000-S							7.83	1.37
E1750-148-6500-M			0.148	3.76	6.500	165.10	13.93	353.82	64.33	286.15	5.79	25.75	7.9	1.384	E1750-148-6500-S	53.59	238.36	4.82	21.45	6.58	1.15		
E1750-148-7000-M					7.000	177.80	15.61	396.49					6.8	1.191	E1750-148-7000-S							5.66	0.99
E1750-148-7500-M					7.500	190.50	17.29	439.17					6.0	1.051	E1750-148-7500-S							5.00	0.88
E1750-148-8000-M	1.750	44.45			8.000	203.20	18.97	481.84					5.3	0.928	E1750-148-8000-S							4.41	0.77
E1750-148-9000-M					9.000	228.60	22.33	567.18					4.4	0.771	E1750-148-9000-S							3.67	0.64
E1750-177-5000-M					5.000	127.00	7.62	193.55					36.6	6.410	E1750-177-5000-S							30.49	5.34
E1750-177-5500-M					5.500	139.70	8.87	225.30					28.5	4.990	E1750-177-5500-S							23.74	4.16
E1750-177-6000-M			0.177	4.50	6.000	152.40	10.12	257.05	105.51	469.33	9.50	42.26	23.3	4.080	E1750-177-6000-S	87.89	390.95	7.91	35.20	19.41	3.40		
E1750-177-6500-M					6.500	165.10	11.37	288.80					19.7	3.450	E1750-177-6500-S							16.41	2.87
E1750-177-7000-M					7.000	177.80	12.61	320.29					17.1	2.990	E1750-177-7000-S							14.24	2.49

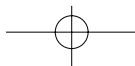

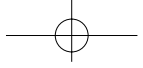

MUSIC WIRE 乐器金属弦线												STAINLESS STEEL 不锈钢金属线											
Catalog Number 编号	Outside Diameter (OD) 外径 (OD)		Wire Diameter (d) 线径 (d)		Free Length L, Approx 自由长度L (估算值)		Ext. L ₁ 拉伸长度 L ₁		Load P at L ₁ L ₁ 下的承载 载荷P		Initial Tension T (Ref. only) 初始张力T (仅供参考)		Spring Rate R 弹性系数 R		Catalog Number 编号	Load P at L ₁ L ₁ 下的承载 载荷P		Initial Tension T (Ref. only) 初始张力T (仅供参考)		Spring Rate R 弹性系数 R			
	in	mm	in	mm	in	mm	in	mm	lb	N	lb	N	lb/in	N/mm		lb	N	lb	N	lb/in	N/mm		
E1750-177-7500-M					7.500	190.50	13.86	352.04					15.1	2.640	E1750-177-7500-S							12.58	2.20
E1750-177-8000-M			0.177	4.50	8.000	203.20	15.11	383.79	105.51	469.33	9.50	42.26	13.5	2.360	E1750-177-8000-S	87.89	390.95	7.91	35.20			11.25	1.97
E1750-177-9000-M					9.000	228.60	17.61	447.29					11.2	1.961	E1750-177-9000-S							9.33	1.63
E1750-207-5000-M					5.000	127.00	6.84	173.74					80.2	14.050	E1750-207-5000-S							66.81	11.70
E1750-207-5500-M					5.500	139.70	7.84	199.14					63.2	11.070	E1750-207-5500-S							52.65	9.22
E1750-207-6000-M	1.750	44.45			6.000	152.40	8.83	224.28					52.1	9.120	E1750-207-6000-S							43.40	7.60
E1750-207-6500-M			0.207	5.26	6.500	165.10	9.83	249.68	162.17	721.37	14.59	64.90	44.3	7.760	E1750-207-6500-S	135.09	600.90	12.15	54.06			36.90	6.46
E1750-207-7000-M					7.000	177.80	10.82	274.83					38.6	6.760	E1750-207-7000-S							32.15	5.63
E1750-207-7500-M					7.500	190.50	11.82	300.23					34.2	5.990	E1750-207-7500-S							28.49	4.99
E1750-207-8000-M					8.000	203.20	12.82	325.63					30.6	5.360	E1750-207-8000-S							25.49	4.47
E1750-207-9000-M					9.000	228.60	14.81	376.17					25.4	4.450	E1750-207-9000-S							21.16	3.71
T33090					4.055	103.00	7.252	184.20					21.6	3.780	T43090							17.99	3.15
T33100					5.000	127.00	10.118	257.00					13.5	2.360	T43100							11.25	1.97
T33110	1.772	45.00	0.157	4.00	6.417	163.00	14.409	366.00	81.15	361.00	12.25	54.49	8.6	1.510	T43110	67.60	300.71	10.20	45.39			7.16	1.26
T33120					8.780	223.00	21.575	548.00					5.4	0.940	T43120							4.50	0.78
T33130					11.929	303.00	31.102	790.00					3.6	0.630	T43130							3.00	0.53
T33210					4.528	115.00	7.929	201.40					25.3	4.430	T43210							21.07	3.69
T33220					5.591	142.00	11.024	280.00					15.8	2.770	T43220							13.16	2.31
T33230	1.969	50.00			7.205	183.00	15.709	399.00	101.38	451.00	15.20	67.63	10.2	1.780	T43230	84.45	375.68	12.66	56.33			8.50	1.48
T33240					9.843	250.00	23.465	596.00					6.3	1.110	T43240							5.25	0.93
T33250					13.386	340.00	33.780	858.00					4.2	0.740	T43250							3.50	0.62
E2000-177-5500-M			0.177	4.50	5.500	139.70	8.99	228.35					24.2	4.240	E2000-177-5500-S							20.16	3.53
E2000-177-6000-M					6.000	152.40	10.52	267.21					18.7	3.270	E2000-177-6000-S							15.58	2.72
E2000-177-6500-M					6.500	165.10	12.04	305.82					15.3	2.680	E2000-177-6500-S							12.74	2.23
E2000-177-7000-M					7.000	177.80	13.57	344.68	92.95	413.46	8.37	37.23	12.9	2.260	E2000-177-7000-S	77.43	344.41	6.97	31.01			10.75	1.88
E2000-177-7500-M					7.500	190.50	15.10	383.54					11.1	1.944	E2000-177-7500-S							9.25	1.62
E2000-177-8000-M					8.000	203.20	16.62	422.15					9.8	1.716	E2000-177-8000-S							8.16	1.43
E2000-177-9000-M					9.000	228.60	19.67	499.62					7.9	1.384	E2000-177-9000-S							6.58	1.15
E2000-177-10000-M	2.000	50.80			10.000	254.00	22.73	577.34					6.6	1.156	E2000-177-10000-S							5.50	0.96
E2000-207-5500-M					5.500	139.70	7.98	202.69					52.5	9.190	E2000-207-5500-S							43.73	7.66
E2000-207-6000-M					6.000	152.40	9.17	232.92					41.1	7.200	E2000-207-6000-S							34.24	6.00
E2000-207-6500-M					6.500	165.10	10.35	262.89					33.8	5.920	E2000-207-6500-S							28.16	4.93
E2000-207-7000-M			0.207	5.26	7.000	177.80	11.54	293.12	143.12	636.63	12.88	57.29	28.7	5.030	E2000-207-7000-S	119.22	530.31	10.73	47.72			23.91	4.19
E2000-207-7500-M					7.500	190.50	12.73	323.34					24.9	4.360	E2000-207-7500-S							20.74	3.63
E2000-207-8000-M					8.000	203.20	13.91	353.31					22.0	3.850	E2000-207-8000-S							18.33	3.21
E2000-207-9000-M					9.000	228.60	16.29	413.77					17.9	3.130	E2000-207-9000-S							14.91	2.61
E2000-207-10000-M					10.000	254.00	18.66	473.96					15.0	2.630	E2000-207-10000-S							12.50	2.19
T33330					5.000	127.00	8.567	217.60					29.1	5.090	T43330							24.24	4.24
T33340					6.181	157.00	11.890	302.00					18.2	3.180	T43340							15.16	2.65
T33350	2.165	55.00	0.197	5.00	7.953	202.00	16.850	428.00	122.07	543.00	18.50	82.28	11.6	2.040	T43350	101.68	452.32	15.41	68.54			9.66	1.70
T33360					8.937	227.00	23.189	589.00					7.3	1.280	T43360							6.08	1.07
T33370					14.843	377.00	36.260	921.00					4.8	0.840	T43370							4.00	0.70

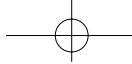

MUSIC WIRE 乐器金属弦线													STAINLESS STEEL 不锈钢金属线									
Catalog Number 编号	Outside Diameter (OD) 外径 (OD)		Wire Diameter (d) 线径 (d)		Free Length L, Approx 自由长度L (估算值)		Ext. L ₁ 拉伸长度 L ₁		Load P at L ₁ L ₁ 下的承载 载荷P		Initial Tension, T (Ref. only) 初始张力T (仅供参考)		Spring Rate R 弹性系数 R		Part Number 编号	Load P at L ₁ L ₁ 下的承载 载荷 P		Initial Tension, T (Ref. only) 初始张力T (仅供参考)		Spring Rate R 弹性系数 R		
	in	mm	in	mm	in	mm	in	mm	lb	N	lb	N	lb/in	N/mm		lb	N	lb	N	lb/in	N/mm	
TH33380	1.575	40.00	0.236	6.00	5.512	140.00	7.874	200.00	307.62	1368.30	36.87	164.00	130.24	22.81								
TH33390					15.748	400.00	24.803	630.00	268.66	1195.00	36.42	162.00	33.69	5.90								
TH33400	1.969	50.00	0.236	6.00	5.512	140.00	8.858	225.00	428.96	1908.00	27.66	123.01	69.32	12.14								
TH33410					15.748	400.00	30.906	785.00	190.06	845.40	21.00	93.40	13.93	2.44								
TH33420	2.008	51.00	0.256	6.50	34.488	876.00	72.283	1836.00	238.27	1059.84	20.68	92.00	6.85	1.20								
TH33440					11.811	300.00	20.669	525.00	277.69	1235.16	17.72	78.80	33.35	5.84								
TH33450	2.362	60.00			35.433	900.00	82.677	2100.00	248.61	1105.80	13.08	58.20	5.54	0.97								
TH33460	2.362	40.00			6.299	160.00	8.071	205.00	411.96	1832.40	26.10	116.10	247.35	43.32								
TH33470					13.780	350.00	18.701	475.00	425.83	1894.10	27.18	120.90	92.04	16.12								
TH33480	1.772	45.00			5.709	145.00	7.677	195.00	426.36	1896.45	27.23	121.10	230.39	40.35								
TH33490	1.969	50.00	0.276	7.00	6.299	160.00	9.252	235.00	331.10	1472.75	21.14	94.01	119.28	20.89								
TH33500					13.780	350.00	21.850	555.00	323.18	1437.50	20.62	91.70	42.60	7.46								
TH33510	2.362	60.00			6.299	160.00	10.039	255.00	258.38	1149.29	16.50	73.40	73.49	12.87								
TH33520					13.780	350.00	25.394	645.00	263.37	1171.45	13.85	61.60	23.87	4.18								
TH33530	1.969	50.00			7.087	180.00	9.449	240.00	484.88	2156.74	30.85	137.20	218.35	38.24								
TH33540					15.748	400.00	22.244	565.00	476.18	2118.07	30.40	135.20	78.00	13.66								
TH33550	2.362	60.00			7.087	180.00	10.433	265.00	387.82	1725.04	24.73	110.00	123.28	21.59								
TH33560					15.748	400.00	25.787	655.00	397.17	1766.59	25.34	112.70	42.08	7.37								
TH33570	2.756	70.00			7.087	180.00	11.417	290.00	345.44	1536.52	22.05	98.10	84.85	14.86								
TH33580					15.748	400.00	30.315	770.00	348.74	1551.19	22.28	99.10	25.47	4.46								
TH33590	1.969	50.00	0.354	9.00	39.370	1000.00	100.394	2550.00	367.11	1632.90	14.10	62.70	9.25	1.62								
TH33600					12.598	320.00	16.535	420.00	745.36	3315.38	47.50	211.30	201.39	35.27								
TH33610	1.969	50.00			13.780	350.00	17.323	440.00	1063.21	4729.14	67.67	301.00	319.18	55.90								
TH33620	2.362	60.00			11.811	300.00	15.551	395.00	742.14	3301.03	48.34	215.00	215.43	37.73								
TH33630	2.758	70.00			11.811	300.00	16.929	430.00	628.30	2794.70	40.02	178.00	130.59	22.87								
TH33640	3.150	80.00			11.811	300.00	18.504	470.00	543.30	2416.60	34.62	154.00	86.33	15.12								

LOOKING FOR A SPECIAL FINISH FOR YOUR SPRINGS OR WASHERS? SEE PAGE 282.
弹簧或者垫圈寻找特殊末道漆层? 见第282页。

